

# VESTEL

---

---

86" (218cm) DIGITAL SIGNAGE DISPLAY

---

---

USER MANUAL

**XD86G-2H**

ENGLISH



## Table of Contents

Important Safety Information.....	2
General View.....	6
Control Buttons on the Display .....	7
Connecting the external IR Receiver .....	8
Turning the Display On/Off .....	8
Remote Control.....	10
General Use .....	11
Initial Setup.....	11
Home Screen .....	12
Display Settings Menu Content .....	12
Operating System Settings Menu Content.....	18
Installing Third Party Applications .....	19
Connectivity .....	19
APPS.....	20
Internet Browser.....	21
Vsign Lite .....	21
Media Player .....	22
CEC and CEC RC Passthrough.....	23
Changing the Start and Settings URL's.....	24
HTML5 CMS Launcher .....	24
OSD Rotation Support .....	24
HDMI Out.....	24
Real Time Clock (RTC).....	24
Crestron Connected .....	25
Controlling With An External PC .....	25
RS232/LAN Command Table .....	27
RS232 HEX Commands.....	46
Maximum Pixel Rates .....	50
Input Matrix .....	50
Supported Media Formats from USB .....	51
System Features.....	54
Accessories Included.....	55
Licence Notification.....	55
Vesa Wall Mount Measurements .....	56
Installation On An Indented Wall.....	57

## Important Safety Information



**CAUTION:** TO REDUCE THE RISK OF ELECTRIC SHOCK DO NOT REMOVE COVER (OR BACK). NO USER-SERVICEABLE PARTS INSIDE. REFER SERVICING TO QUALIFIED SERVICE PERSONNEL.

**OPS USAGE WARNING:** Do not plug the OPS unit while the Display is turned on. Turn on the OPS unit using the remote control or the buttons on the Display, do not turn it on using the buttons on the device itself.

### Please read these instructions fully and carefully before use and keep for future reference

**WARNING:** This device is not intended for use by persons (including children) without physical, sensory or mental capabilities, or lack of experience and/or knowledge unless they have been given supervision or instruction concerning use of the device by a person responsible for their safety.

- This product is for indoor use only.
- Use this product at an altitude of less than 5000 metres above the sea level and in dry locations and in regions with moderate or tropical climates.
- Please keep this manual for further use.
- Unplug your product before starting to clean. Do not clean the product when it is on. Do not use liquid or aerosol cleaners. Use a damp cloth for cleaning. If that does not help, please use LCD display cleaners. Do not apply the cleaner directly on the product.
- To prevent breakdown, do not use non-advised accessories.
- Please do not place your product near wash basins, sinks, water pans, pools, etc.
- Do not expose the product to dripping or splashing of liquids and do not place objects filled with liquids, such as vases, cups, etc. on or over the product (e.g. on shelves above the Display).
- Please leave at least 5 cm of free space between the product and walls or other furnitures for ventilation purposes.
- That product can only be started by the defined power source on its rating plate. For further information, please contact with your dealer.
- As a safety precaution, a three-wired grounding plug is given with the product. As a safety precaution, please do not make any change on the grounding plug. Always use earthed socket outlet for product.
- Please provide the plug and socket to supply the needed power for appliance.

- Please place the product in a position that electric cables cannot be affected by the operations on the product.
- Follow all warnings and instructions marked on the product.
- Follow the on screen instructions for operating the related features.
- To prevent the risk of fire or electric shock, please do not overuse the plugs and extension cords. Please do not open the lid of the monitor to service yourself. If the required service needs are not met by an authorized service, dangerous voltage and other risks may occur.
- If you will not use the product for a long period of time, unplug the power cord from the mains.
- Put the product on a well-ventilated place and prevent from bright light, overheat and damp.
- The product should be kept in 0 °C - 40 °C. Otherwise, the appliance may be damaged permanently.
- Plug the appliance to a grounded outlet. Always use the grounded power cord supplied with your product. Manufacturer is not responsible for any damage caused unearthed usage.
- The socket-outlet shall be installed near the equipment and shall be easily accessible.
- Do not stay in contact with the parts of the product that become hot for long periods of time. Doing so may result in low-temperature burns.
- The LCD panel used in this product is made of glass. Therefore, it can break when the product is dropped or applied with impact. Be careful not to be injured by broken glass pieces in case the LCD panel breaks.
- Usage of the monitor must not be accompanied by fatal risks or dangers that, could lead directly to death, personal injury, severe physical damage or other loss, including nuclear reaction control in nuclear facility, medical life support system, and missile launch control in a weapon system.
- Do not expose the product to direct sunlight or do not place open flames such as lit candles on the top of or near the product.
- Do not place any heat sources such as electric heaters, radiators, etc. near the product.
- In order to prevent a potential electrical shock, in extreme weather (storms, lightning) disconnect the product from the mains.
- Do not touch the controls other than those described in the operating instructions. Improper adjustment of controls not described in the instructions can cause damage, which often requires extensive adjustment work by a qualified technician.
- Do not shake the product. Ensure that it stays in a balanced stance on its position.
- Do not throw or drop any object on your product.

- Do not interfere on your products screen or any other surface with a sharp object.
- Do not keep your product in a humid environment.
- Do not keep your product in an extremely cold environment.
- Do not keep your product in an extremely hot environment.
- Do not place the product on the floor and inclined surfaces.
- To avoid danger of suffocation, keep plastic bags out of the reach of the babies, children and domestic animals.

### **Vent holes of the product**

The vent holes are designed to provide the product to work constantly and prevent it from overheating. Do not block these openings in anyway. For the same reason, please do not place your product on beds, sofas, carpets and similar surfaces.

Never insert an object into the product through vents or openings. High voltage flows in the product, and inserting any objects in the vents or openings of the product may cause electric shock, short circuit of the internal parts and/ or fire. For the same reason, do not spill water or liquid on the product.

### **Repair**

Unless a basic implementation on the product is specified by the producers' technical department on a document, do not repair your product by yourself. Otherwise, your guarantee may get suspended and you may risk your health or your product. In case of need, consult your authorized service.

- When the cable is worn off or harmed.
- If the product has been dropped or the cabinet has been damaged.
- If the performance of the product is changed or the appliance needs to be repaired.
- When a liquid was spilled on the product or when objects have fallen into the product.
- When the product has been exposed to rain or water.
- When the product does not operate properly as described in the operating instructions.

### **Replacement parts**

In case the product needs replacement parts, make sure that the service person uses replacement parts specified by the manufacturer, or those with the same characteristics and performance as the original parts. Use of unauthorized parts can result in fire, electric shock and/ or other danger.

### **Safety checks**

Upon completion of service or repair work, request the service technician to perform safety checks to ensure that the product is in proper operating condition.

### **Wall mounting**

When mounting the product on a wall, be sure to install the product according to the method recommended by the manufacturer.

- Read the instructions before mounting the product on the wall.
- The wall mount kit is optional. You can obtain from your local dealer, if not supplied with the product.
- Do not install the product on a ceiling or on an inclined wall.
- Use the specified wall mounting screws and other accessories.
- Tighten the wall mounting screws firmly to prevent the product from falling. Do not over-tighten the screws.

### **Power Cord**

- The power cord is used to disconnect the product from the mains and therefore it must remain readily operable. If the product is not disconnected electrically from the mains, the device will still draw power for all situations even if the product is in standby mode or switched off.
- Use only the power cord supplied with the monitor.
- Do not damage the power cord nor place heavy objects on it, stretch it, over bend it or step on it. Also, do not add extension cords. Damage to the cord may result in fire or electric shock.
- When unplugging the appliance, always pull directly on the plug. Do not pull from the cable when unplugging the appliance.
- Do not use the power cord with a power tap. Adding an extension cord may lead to fire as a result of overheating.
- Do not remove or insert the power plug with wet hands. Doing so could result in electric shock.
- Unplug the power cord if it is not used for a long time.
- Do not attempt to repair the power cord if it is broken or malfunctioning. When damaged it must be replaced, this should only be done by qualified personnel.

### **Especially for child safety**

- Don't allow children to climb on or play with the monitor.
- Don't place the monitor above furniture that can easily be used as steps.
- Remember that children can become excited while watching a program, especially on a "larger than life" monitor. Care should be taken to place or install the monitor where it cannot be pushed, pulled over, or knocked down.
- Care should be taken to route all cords and cables connected to the monitor so that they cannot be pulled or grabbed by curious children.

## Connections

 Be sure to turn off the main power switch and disconnect the plug from the power outlet before connecting/disconnecting cables. Also, read the manual of the equipment to be connected.

Be careful not to confuse the input terminal with the output terminal when connecting cables. Accidentally reversing cables connected to the input and output terminals may cause malfunctions and other problems.

In the case of USB fault condition, maximum current is below 5A.

## Positioning

If a monitor is positioned in an unstable or inclined location, it can be potentially hazardous due to falling. Many injuries, particularly to children, can be avoided by taking simple pre-cautions such as:

- Using fixing devices like wall mount brackets recommended or supplied by the manufacturer.
- Educating children about the dangers of climbing on furniture to reach the monitor or its controls. If your existing product is being retained and relocated, the same considerations as above should be applied

## Transport and Shipping

- Your device must be kept in its original package to protect from damage to its accessories during transport and shipping.
- Keep the product in normal position during transport.
- Do not drop the device during transport and protect it against impacts.
- Damages and faults that occur during transport after the delivery of the appliance to the customer are not included in the warranty cover.
- Product transportation, installation, repair and servicing must be done by qualified technical service personnel.

## Intended Use

- This product is intended to be used in public places such as schools, offices, theatres, places of worship.
- Product is only suitable for connecting commercial mains socket outlets. Do not connect product industrial socket outlets.

## Foreseeable misuse and incorrect use

- For apparatus intended to be used in vehicles, ships or aircraft or at altitudes exceeding 5000m above sea level, for outdoor use or in general for the application other than mentioned in user manual additional requirements may be necessary.



**CAUTION**



Do not leave a static image displayed for prolonged period of time. If a static image is displayed continuously for a long period of time, that image may cause image sticking on the display. This condition is not permanent, but may require a considerable amount of operational display time to dissipate, depending upon the degree of image stick. 120 minutes of continuous motion display will eliminate most image sticking effects at normal room temperature (not lower than 10 C).

As the nature of the TFT technology, you may see some amount of bright, dark, red, green and blue dots and sparklings on the screen, those do not affect the performance of the computer and are not accepted as a defect.

## Warning

This is a class A. In a domestic environment this may cause radio interference in which case the user may be required to take adequate measures.

## BATTERY SAFETY GUIDELINES

Used correctly, domestic batteries are a safe and dependable source of portable power. Problems can occur if they are misused or abused resulting in leakage or, in extreme cases, fire or explosion.

Here are some simple guidelines to safe battery use designed to eliminate any such problems.

- Take care to fit your batteries correctly, observing the plus and minus marks on the battery and appliance. Incorrect fitting can cause leakage or, in extreme cases, fire or even an explosion.
- Replace the whole set of batteries at one time, taking care not to mix old and new batteries or batteries of different types, since this can result in leakage or, in extreme cases, fire or even an explosion.
- Store unused batteries in their packaging and away from metal objects which may cause a short-circuit resulting in leakage or, in extreme cases, fire or even an explosion.

- Remove dead batteries from equipment and all batteries from equipment you know you are not going to use for a long time. Otherwise the batteries may leak and cause damage.
- Batteries must not be exposed to excessive heat such as sunshine, fire or the like.
- Never dispose of batteries in fire or with hazardous or flammable materials as this can cause them to explode. Please recycle dead batteries; do not put with the normal household waste.
- Never attempt to recharge ordinary batteries, either in a charger or by applying heat to them. They may leak, cause fire or even explode. There are special rechargeable batteries which are clearly marked as such.
- Supervise children if they are replacing batteries themselves in order to ensure these guidelines are followed.
- Do not ingest the battery, Chemical Burn Hazard.
- This product or the accessories supplied with the product may contain a coin/button cell battery. If the coin/button cell battery is swallowed, it can cause severe internal burns in just 2 hours and can lead to death.
- Remember that small button cell batteries such as used in some hearing aids, toys, games and other appliances, are easily swallowed by young children and this can be dangerous.
- Keep new and used batteries away from children.
- Make sure battery compartments are secure. If the battery compartment does not close securely, stop using the product and keep it away from children.
- Seek immediate medical attention if you believe batteries might have been swallowed or placed inside any part of the body.
- If leaked battery fluid gets on your skin or clothing, rinse immediately and thoroughly. If it gets into your eye, bathe your eye well rather than rubbing and seek medical treatment immediately. Leaked battery fluid that gets into your eye or your clothing may cause a skin irritation or damage your eye.

## CAUTION

RISK OF EXPLOSION IF BATTERY IS REPLACED BY AN INCORRECT TYPE. DISPOSE OF USED BATTERIES ACCORDING TO THE INSTRUCTIONS.

## Markings on the Product

The following symbols are used **on the product** as a marker for restrictions and precautions and safety instructions. Each explanation shall be considered where the product bears related marking only. Note such information for security reasons.



**Class II Equipment:** This appliance is designed in such a way that it does not require a safety connection to electrical earth.



**Class II Equipment With Functional Earthing:** This appliance is designed in such a way that it does not require a safety connection to electrical earth, the earth connection is used for functional purposes.



**Protective Earth Connection:** The marked terminal is intended for connection of the protective earthing conductor associated with the supply wiring.



**Hazardous Live Terminal:** The marked terminal(s) is/are hazardous live under normal operating conditions.



**Caution, See Operating Instructions:** The marked area(s) contain(s) user replaceable coin or button cell batteries.

Any issues which are caused by customer mis-adjustment of any software including the operating system are not covered by the warranty.

Depending on the model you buy, the actual appearance of the product may differ from the images used in this manual.

## General View

Please note that connection ports and other features shown here may vary depending on the Display model.

### Front Side

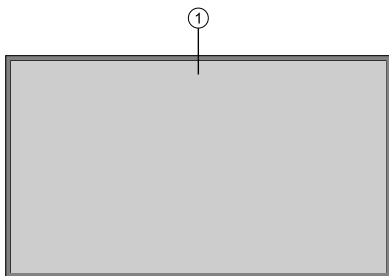

1. LCD Panel

### Rear Side (A)

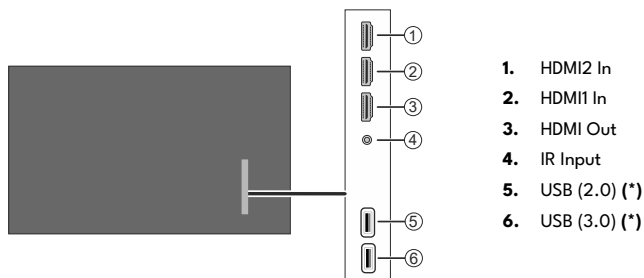

(\*) Supported file formats are listed in the **Supported Media Formats from USB** section.

### Rear Side (B)

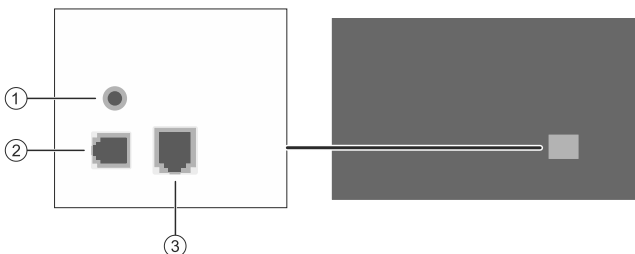

1. Headphone/Line Out or RS232 (3,5 mm)
2. RJ12 (service use only)
3. Ethernet



## Control Buttons on the Display



### **Standby State**

**Centre:** Turn On (\*)

### **Home Screen**

**Up:** Move the focus up / Source menu (\*)

**Down:** Move the focus down / Source menu (\*)

**Left:** Move the focus left / Volume - (\*)

**Right:** Move the focus right / Volume + (\*)

**Centre:** Enter submenu / Select / Standby (\*)

### **Main Menu / Submenu**

**Up:** Move the focus up / Source menu (\*)

**Down:** Move the focus down / Source menu (\*)

**Left:** Move the focus left / Change the setting value / Back (\*)

**Right:** Move the focus right / Change the setting value / Back (\*)

**Centre:** Enter submenu / Exit or Enter submenu (\*)

(\*) Press in and hold or Push Up/Down/Left/Right and hold

### **Video Playback**

**Up:** Volume + / Source menu (\*)

**Down:** Volume - / Main menu (\*)

**Left:** Rewind / Stop (\*)

**Right:** Fast forward / Stop (\*)

**Centre:** Enter submenu / Select / Standby (\*)

## Connecting the external IR Receiver

Before plugging the Display into the mains supply, connect the supplied IR receiver (depends on the model) to the IR input on the Display. Place the IR receiver in sight of your own remote control. Simply operate your remote control whilst pointed at the IR receiver and it will relay the control signal to your Display.

Depending on the model, your Display may have a built-in IR receiver on its cabinet. This IR receiver will not function if the external IR receiver is connected to the Display. Disconnect the external IR receiver if you want to use the built-in IR receiver again.

## Turning the Display On/Off

### Connect power

**IMPORTANT: The Display is designed to operate on 110-240V AC, 50/60 Hz socket.**

After unpacking, allow the Display to reach the ambient room temperature before you connect it to the mains. Plug the power cord into the mains socket outlet.

### For models with detachable power cord

Plug one end (female connector - C13) of the supplied detachable power cord into the power cord inlet (AC IN) on the rear side of the Display. Then plug the other end of the power cord into the mains socket outlet.

Turn on the power switch on the Display - position "2" (  ). The Display will switch into standby mode and the power LED will light up.

**Note:** The behaviour of the Display and the power LED may change depending on the **Power Up Mode** option setting in the **Display Settings > Signage Settings > Power Up Settings** menu and the **Standby Mode Led** option setting in the in the **Display Settings > System Settings > More** menu.

### To switch on the Display

If the Display is in standby mode or quick standby mode, the power LED lights up. To switch on the Display either press the **Standby** button on the remote control or press the centre of the joystick in and hold it down for a few seconds. The Display will then switch on.

### To switch the Display into standby mode

In order to switch the Display into standby mode press and hold the **Standby** button on the remote control. **Power off** dialogue will appear on the screen. Highlight **OK** and press the **OK** button. The Display will switch into standby mode.

### To switch the Display into quick standby mode

In order to switch the Display into quick standby mode either press the **Standby** button on the remote control or press the centre of the joystick in and hold it down for a few seconds (while Home Screen is displayed). Press the button again to go back to operating mode.

**Note:** If the **Power Mode** option (to be found in the **Display Settings > Signage Settings > Power Up Settings** menu) is enabled (**Reactive** mode), the Display will switch into standby mode when the **Standby** button is pressed.

### To switch off the Display

Turn off the power switch on the Display - position "1" (  ). The Display will switch off. To power down the Display completely, unplug the power cord from the mains socket.

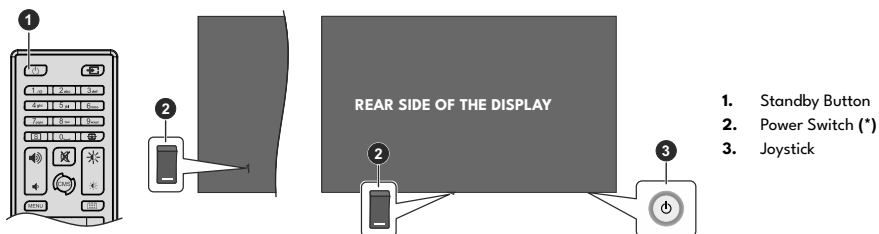

(\*) The location of the power switch may differ depending on the model

<b>Power LED Status</b>	<b>Status of the Display</b>
Not lit	Power on (operating mode)
Lit	Power off (standby mode, quick standby mode)
Flashing (slow)	Turning on or off
Flashing (fast)	Software update

## Remote Control

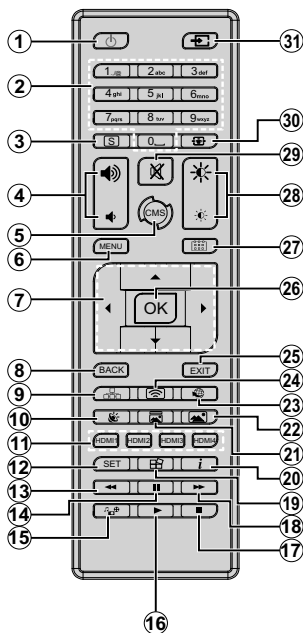

### Inserting the Batteries into the Remote

The remote may have a screw that secures the battery compartment cover onto the remote control first (or this may be in a separate bag). Remove the screw, if the cover is screwed on previously. Then remove the battery compartment cover to reveal the battery compartment. Insert two 1.5V - size **AAA** batteries. Make sure the (+) and (-) signs match (observing correct polarity). Do not mix old and new batteries. Replace only with same or equivalent type. Place the cover back on. Secure the cover again with the screw, if any.

### Standby Button

Press and hold the **Standby** button on the remote control. **Power off** dialogue will appear on the screen. Highlight **OK** and press the **OK** button. The Display will switch into standby mode. Press briefly and release to switch the Display into quick standby mode or to switch on the Display when in quick standby or standby mode.

1. **Standby:** Quick Standby / Standby / On
2. **Numeric buttons:** Enters a number or a letter in the text box on the screen
3. **Signage:** Displays the **Signage Settings** menu
4. **Volume +/-:** Increases or decreases the volume
5. **CMS:** Opens the predefined **Auto Launch (\*)** preference

(\*) This setting can be found in the **Display Settings > Signage Settings > Power Up Settings** menu. If it set to **Disabled**, this button will have no function

6. **Menu:** Opens the **Display Settings** menu
7. **Directional buttons:** Helps navigate menus, content, etc.
8. **Back/Return:** Returns to previous screen
9. **Network:** Displays the **Network & Internet** menu
10. **Sound:** Displays the **Sound** menu
11. **HDMI Buttons:** Switches to the selected HDMI input source, if available
12. **Set:** Freezes the currently displayed image on the screen. Press again to cancel the freeze function
13. **Rewind:** Moves frames backwards in media such as movies
14. **Pause:** Pauses the media being played
15. **Media Player:** Launches the media player application
16. **Play:** Resumes playing the paused media, starts to playback from the beginning
17. **Stop:** Stops the media being played
18. **Fast forward:** Moves frames forward in media such as movies
19. **Video Wall:** Displays the **Video Wall Settings** menu
20. **Info:** Displays information about on-screen content, if available
21. **Picture Mode:** Opens the picture mode selection screen. Use the Left or Right directional button to change the picture mode
22. **Picture:** Displays the **Picture** menu
23. **Internet:** Launches the open browser application
24. **Wireless Display:** Opens the wireless display connection screen (depends on the model)
25. **Exit:** Closes and exits from displayed menus or returns to previous screen
26. **OK:** Confirms user selections
27. **Scheduler:** Displays the **Scheduler Settings** menu
28. **Brightness +/-:** Increases or decreases the brightness of the screen
29. **Mute:** Completely turns off the volume of the Display
30. **Picture Zoom:** Changes the aspect ratio of the screen
31. **Source:** Shows all available content sources

## General Use

Use the remote control when navigating through the menus and performing initial setup process.

### Operation with the Remote Control

Press the **Back/Return** or **Exit** button to display or return to the Home Screen. You can navigate through the elements situated in the centre of the Home Screen using the remote control buttons. Press the **Menu** button to display the **Display Settings** menu. Use the directional buttons to move the focus, proceed, adjust some settings and press **OK** to make selections in order to make changes, set your preferences, enter a sub-menu, launch an application, etc. Press the **Back/Return** or **Exit** button to return to the previous menu screen or step, close a menu or exit an application, etc.

### Input Selection

Once you have connected external systems to your Display, you can switch to different input sources. Press the **Source** button on your remote control. Use the directional buttons to highlight a source option and press the **OK** button to switch to that source. You can also use the dedicated HDMI buttons on your remote (depends on the model) to switch directly to the selected HDMI input.

### Adjusting the Volume and Brightness

You can adjust the volume by using the **Volume +/-** buttons and the brightness by using the **Brightness +/-** buttons on the remote.

You can also adjust the brightness using the **Brightness** option in the **Display Settings > Picture** menu. Press the **Menu** button on the remote to display the **Display Settings** menu.

## Initial Setup

When turned on for the first time, initial setup should be performed. Follow the on-screen instructions to setup your Display. The installation wizard will guide you through the setup process. Use the directional buttons and the **OK** button on the remote to select, set, confirm and proceed. You can use the **Back** button to go back to the previous steps and change your selections.

#### 1. Language

The language selection options will be listed on the screen. Select the desired language from the list and press **OK** to continue.

#### 2. Country

In the next step select your country from the list and press **OK** to continue.

#### 3. Login

You will be asked to define a PIN at this point. Enter a PIN twice for confirmation using the virtual keyboard and then highlight **LOGIN** and press **OK**. You have to enter this PIN

if you are asked to enter a PIN for any menu operation later. To skip this step highlight **Skip Pin** and press **OK**.

#### 4. Signage Settings

The **Signage Settings** menu will be displayed next. The **Set ID**, **OSD Orientation**, and **NTP server** options can be configured using this menu. The **Model name**, **Serial number**, and **Software version** options are for information only. You can save the model information data of the Display to a connected USB storage device using the **Save model information** option. You can also copy database files from a connected USB storage device to the Display using the **Clone from USB** option. Refer to the **Signage Settings** section for more information on the options of this menu. After the settings are completed, highlight **Next** and press **OK** to continue.

#### 5. Auto Launch

In this step you can set your Auto Launch preference for the Display. **Disabled**, **HTML5 CMS Launcher**, **Open Browser**, **SignLite**, **Select Source**, and **Select Application** options will be available. Set to **Disabled** if you don't want to use this functionality. In this case, the Display will open with the Home Screen. For the **Select Source** and **Select Application** options you will have to set the available source or application of your choice. You can change your preference any time later using the **Auto Launch** option in the **Display Settings > Signage Settings > Power Up Settings** menu.

#### 6. Display Operation Mode

The **Display Operation Mode** selection screen will be displayed next. For normal operation set the **Power Mode** to **Reactive**. Set to **Eco** for an energy-efficient operation. In this mode your Display's settings will be configured to reduce the energy consumption. Note that, in **Eco** mode the RS232/LAN Commands will not work when the Display is in standby mode. You can also set your preference for the HDMI Wake Up feature here. Refer to the **Power Up Settings** section for more information on the options of this menu. After the settings are completed, highlight **Next** and press **OK** to continue.

#### 7. Network/Internet Settings

The **Network/Internet Settings** menu will be displayed next. You can configure your Display's network settings using the options of this menu.

##### Wired Connection

Connect the Display to the network using an Ethernet cable before proceeding with the wired connection. Set the **Network Type** option to **Wired Device**.

You can use the **Advanced Settings** menu options to set the IP and DNS parameters manually. Highlight **Save** and press **OK** to save settings when complete.

You can also enable or disable the Networked Standby Mode feature by setting this option accordingly. This is a standard that allows a device to be turned on or woken up by a network message when it is in standby mode.

Refer to the **Networked Standby Mode** section for more information.

The connection status information will be displayed at the bottom of the screen.

### Wireless Connection

Set the **Network Type** option to **Wireless Device**. The settings menu will change for the wireless connection. Refer to the **Network & Internet** section for detailed information on how to use this menu. After the settings are completed, press the **Back/Return** button to return to the initial setup. Highlight **Next** and press **OK** to continue.

### 8. Manufacturer Usage & Diagnostic

You will be asked to give your consent to the collection of your data. Read the text on the screen for detailed information. Highlight **Accept** and press **OK** to give your consent and proceed. To skip without giving your consent, select **Skip**.

When the initial setup is completed Home Screen will be displayed. You can repeat the initial setup process and reset the Display's settings to the factory defaults anytime using the **First time installation** option in the **Display Settings > Signage Settings** menu. You can access the **Display Settings** menu by pressing the **Menu** button on the remote.

**Note:** You will be asked to enter the PIN to perform initial setup. If you didn't define a PIN during the initial setup, you can use the default PIN. Default PIN is set to **0000**.

## Home Screen

After the initial setup, the Display will open with the Home Screen. You can go to the **Display Settings > Signage Settings > Power Up Settings** menu to change the **Auto Launch** setting. If it is set to **Disabled**, the Display will always open with the Home Screen. Press the **Back/Return** or **Exit** button to display or return to the Home Screen.

Following options will be available on the Home Screen:

- **HTML5 CMS Launcher:** Activate the CMS launcher or configure its settings using the related options. Refer to the **HTML5 CMS LAUNCHER** section for more information
- **Media Player:** Launches the media player application
- **Signage Settings:** Displays the **Signage Settings** menu
- **Applications:** Displays all applications installed on the Display

## Display Settings Menu Content

You can configure the settings of your Display using the **Display Settings** menu. In order to access this menu, press the **Menu** button on the remote. Available options will be listed.

Note that some options in the **Display Settings** menu may not be available depending on the model of your Display and its features.

### Picture

**Picture Mode:** Set the picture mode to suit your preference or requirements. Picture mode can be set to one of these options: **Game, Sports, Signage, Natural, and Text**.

Some of the picture settings will be adjusted according to the selected picture mode.

**Energy Saving:** Set your preference for energy saving. If set to **Eco** the Display will adjust the energy consumption accordingly. Set to **Off** to turn this setting off. Some other picture settings may not be changed if this option is set to **Eco**.

When the Display is not in use, you can switch off or disconnect the Display from the mains plug to reduce or cut the energy consumption.

**Contrast:** Adjust the contrast value of the screen.

**Brightness:** Adjust the brightness value of the screen.

**Sharpness:** Adjust the sharpness value for the objects displayed on the screen.

**Colour:** Adjust the colour saturation value of the screen.

**Backlight:** Adjust the backlight level of the screen manually. This item will not be available if the **Energy Saving** option is set to **Eco**.

**Picture Zoom:** Set the aspect ratio of the screen. To make the image fit the screen exactly, you can select one of the predefined options according to your preference.

**Note:** It is recommended to set the **Picture Zoom** option to **Auto**, if the Display's OSD Orientation is in one of the portrait modes. Otherwise, the picture may look stretched-out.

### Advanced Settings

**Dynamic Contrast:** Set your preference for the dynamic contrast ratio setting. **High, Medium, Low, and Off** options will be available.

**Microdimming:** Set your micro dimming preference. **High, Medium, Low, and Off** options will be available. While this feature is active, it will enhance contrast locally for each defined zone.

**Colour Space:** Set your colour space preference. **Auto, Rgb, and Yuv** options will be available.

**Colour Temperature:** Set your colour temperature preference. **Normal (9300K), Warm, Cold, and User** options will be available.

**Gamma Slider:** Adjust the light and dark balance manually.

**Noise Reduction:** Set your preference for noise reducing functionality. **High, Medium, Low, and Off** options will be available.

**Colour Shift:** Adjust the colour tone manually.

**Film Mode:** It is the function for 3:2 or 2:2 cadence detection for 24 fps film content and improves the side effects (like interlacing effect or judder) which are caused by these pull down methods. Set your Film Mode preference as **Auto** or turn it off by setting to **Off**.

**HDMI RGB Range:** This setting should be adjusted according to input RGB signal range on HDMI source. It can be limited range (16-235) or full range (0-255). Set your HDMI RGB range preference. **Auto**, **Full**, and **Limit** options will be available.

**Reset:** Reset the video settings to factory default settings.

**Note:** Adjusting some of the settings may not affect the picture on the launcher menu.

## Sound

**Speakers:** To hear the Display audio from the connected compatible audio device set to **External Audio System**. Set to **Display Speakers** to use the speakers of your Display for sound output.

**Dolby Audio Processing:** With Dolby Audio Processing, you can improve the sound quality of your Display. Press **OK** to see the options and set.

**Sound mode:** Highlight the **Sound Mode** option and press **OK** to see the preset sound modes. **Smart**, **Music**, **Movie**, and **News** options will be available. Highlight the option you prefer and press **OK** to set.

**Balance:** Adjust the left and right volume balance for speakers and headphones.

**Digital Output:** Set the digital sound output preference. **PCM**, **Bypass**, and **Auto** options will be available. Highlight the option you prefer and press **OK** to set.

**Note:** This option should be set to **PCM** instead of **Auto**, if the connected external audio device does not support DD. Otherwise, no sound will be heard from the connected device.

**AVL:** With this option, you can set the Display to automatically level out sudden volume differences. Typically at the beginning of adverts or when you are switching sources. Turn this option on/off by pressing **OK**.

**HDMI/ARC Latency:** Adjust the delay value for HDMI/ARC.

**Audio Output Latency (depends on the model):** Adjust the delay value for SPDIF.

**Reset:** Reset the sound settings to factory default settings.

## Network & Internet

You can configure your Display's network settings using the options of this menu.

**Wi-Fi:** Turn the wireless LAN (WLAN) function on and off. Highlight and press **OK** to turn this function on and off.

### Available networks

When the WLAN function is turned on, a few available wireless networks will be listed. Highlight **See all** and press **OK** to see all networks. Select one and press **OK** to connect.

You may be asked to enter a password to connect to the selected network, in case the network is password protected.

You can see the status of the connection under the name of your network. It will read 'Connected' if the connection is successful. Highlight the network that your Display is connected to and press **OK** to see the information on the connection, such as the Internet connection status (as **Connected - Not connected**), and if connected, the IP/MAC addresses and signal strength. You can also set a proxy server, change the IP settings using the related options and delete the connected wireless network profile using the **Forget network** option here.

**Note:** The IP Setting changes will not take immediate effect but becomes active after the Display is turned off and then back on again.

## Other Options

**Add new network:** Add networks with hidden SSID's (network name). You can use this option in order to connect to the hidden networks by entering their names manually. This item will not be available if the **Wi-Fi** option is not turned on.

**Networked Standby Mode:** This is a standard that allows a device to be turned on or woken up by a network message when it is in standby mode. Highlight and press **OK** to turn this function on and off. Refer to **Networked Standby Mode** section for more information.

## Ethernet

Under the **Ethernet** caption, you can see the LAN status (as **Connected - Not connected**) and also MAC/IP addresses if connected. You can also set a proxy server and change the IP settings using the related options.

**Connected/Not connected:** Displays the status of the connection (via Ethernet), IP and MAC addresses.

**Proxy settings:** Set a HTTP proxy for browser manually. This proxy may not be used by other apps.

**IP settings:** Configure your Display's IP settings.

**Note:** The IP Setting changes will not take immediate effect but becomes active after the Display is turned off and then back on again.

## Signage Settings

### Device Info

Display device information menu options.

**Set ID:** Sets the device ID. You can set a number using the virtual keyboard in order to identify your Display.

**Software Version:** Displays current software version. Press **OK** to open the update centre. In addition to the current software version, the last update date information can be found here. The **CHECK UPDATE** option will be highlighted. Press **OK** to start a manual search for a software update. To do this, your Display should be connected to the Internet. If any update is

found, you can download and install the new software using the related options. Follow the on-screen instructions to complete the process.

**Serial Number:** Displays serial number of the Display. (Cannot be changed by the user)

**Model Name:** Displays model name of the Display. (Cannot be changed by the user)

**Save Model Information:** Copies the model information data of the Display to a connected USB device.

**Display Life Time:** Displays the lifetime of the Display in hours.

## Controls

**OSD Orientation:** Sets the OSD (On Screen Display) rotation of your Display. **Landscape, Portrait1, Portrait2,** and **Auto** options are available.

When set to **Auto**, the Display will use the integrated gyro sensor to detect its current rotation automatically and change the OSD orientation accordingly. The integrated gyro sensor and the **Auto** option may not be available depending on the model of your Display and its features.

**Note:** Each time the OSD orientation is changed from portrait to landscape or vice versa, the Display should be turned off (standby mode) and then back on.

**Pixel shift:** Enables or disables pixel shifting. This option can be used to avoid image retention (after image effects) that can occur when displaying fixed patterns or still images for long periods of time. If enabled, the picture and OSD (On-Screen Display) will be shifted at specified time intervals.

**No Signal:** Sets the behaviour preference of the Display, when no signal is detected from the currently set input source. **Failover, Input Search,** and **Disabled** options are available. Set to **Disabled** to disable this function.

If **Failover** is selected the Display checks the connected USB device for available files to play. If no playable files are available or there is no USB device connected to the Display, the No Signal Image will be displayed. If there isn't any No Signal Image available, No Signal OSD will be displayed on the screen. The setting of the **USB Auto Play** option in the **Display Settings > System Settings > More** menu is not important, in Failover mode it will function anyway.

If **Input Search** is selected, available input sources will be listed. Highlight the options you want and press **OK** to select. The Display will search all selected input sources consecutively to find signal. If no signal is detected from other available sources, the Display will turn off automatically after completing a cycle.

### How to install No Signal Image

Install the file you want to use onto the root directory of any USB storage device and name it as "NoSignalImage.png". Connect the USB storage device to the Display. Highlight the **USB Operations** option in the **Display Settings > Signage Settings > USB** menu and press **OK**.

**No Signal Delay:** Sets a delay value to the "No Signal" preferences when the Display is in No Signal state. After the set delay time has expired "No Signal" preferences will be applied.

**No Signal Power Off:** When enabled the Display will turn itself off after a specified period of time (defined in the **No Signal Timer** option), if no signal is received from the selected source.

This feature will only work if all of the following circumstances occur:

- **No Signal** option is set to **Failover**.
- USB device is not connected to the Display / USB device is connected but there are no playable files installed on the USB device.

**No Signal Timer:** You can define a shut-off timer for the Display using this option. When the Display is in No Signal state and No Signal OSD is displayed on the screen, it will go into standby mode after the time set here has expired.

**Panel Lock:** Set to **On** to prohibit the use of the button/s on the Display.

**RCU Inhibit:** Set to **On** to inhibit the use of the remote. Remote control will function in standby mode independently from the setting of this option.

To turn this option off and be able to use the remote again, press the **MENU/M-1-9-7-3-Back/Return** buttons on the remote consecutively.

**UART0:** Select ASCII/HEX protocol for UART 0. Default value is ASCII. There is no need to restart the Display after selection in order to work with the protocols correctly. If the selection is changed, the latest selected protocol will be preserved and started when the Display is booted up.

Note that ASCII/HEX selection is not working while debug logs are enabled. If it is wrongly changed to HEX while debug logs are enabled, revert the selection to ASCII and reboot the Display in order to correct the debug logs and the ASCII protocol behaviour.

Also note that HEX protocol will work with the baud rate value 19200 for UART 0.

**UART1:** Select ASCII/HEX protocol for UART 1. Default value is HEX. There is no need to restart the Display after selection in order to work with the protocols correctly. If the selection is changed, the latest selected protocol will be preserved and started when the Display is booted up.

Note that ASCII/HEX selection is always working as expected. It does not matter if the debug logs are enabled or not.

Also note that HEX protocol will work with the baud rate value 9600 for UART1

**Menu Lock:** You can block the usage of the menu button on the remote by setting this item as **All menus**. If set to **All menus**, the **Signage Settings** will not be accessible from the Home Screen and when you press the **Menu** or **Signage** button on the remote, you will be asked to enter the PIN that you have defined during the initial setup process. If



you didn't define a PIN during the initial setup, you can use the default PIN. Default PIN is set to **0000**. Set to **Off** to disable this function.

**Auto Source Switch:** If this option is enabled the Display will switch to the currently active HDMI source automatically when a device is connected to the Display through the HDMI1 or HDMI2 input socket. Set to **Enabled** to enable this feature.

When the HDMI source is removed the Display will switch to other active HDMI source. If there isn't any other device connected to the Display and the HDMI Wake UP option for the related HDMI source is enabled the Display will switch into the standby mode.

There is also a 3-second restriction for the successive connected HDMI sources. This means, second HDMI device must be plugged in 3 seconds after the first HDMI device is plugged in.

**Note:** This feature applies for HDMI1 and HDMI2 input sockets only. Refer to the **General View** section to see the HDMI inputs.

**Bluetooth:** Switches on or off the Bluetooth functionality. Set to **Enabled** to enable this feature.

**Bluetooth Remotes & Accessories:** You can use wireless accessories, such as remote controls, headphones, keyboards or game controllers with your Display. Add devices to use them with your Display. Select this option and press **OK** to start searching available devices in order to pair them with your Display. If available highlight the **Add accessory** option and press **OK** to start the search. Set your device to pairing mode. Available devices will be recognised and listed or pairing request will be displayed. To start pairing, select your device from the list and press **OK**, or highlight **OK** and press **OK** when the pairing request appears.

Connected devices will also be listed here. To unpair a device, highlight it and press **OK**. Then highlight the **Unpair** option and press **OK**. Then select **OK** and press **OK** again to unpair the device from the Display. You can also change the name of a connected device. Highlight the device and press **OK**, then highlight **Change name** and press **OK** again. Press **OK** again and use the virtual keyboard to change the name of the device.

If the **Bluetooth** option in the **Controls** menu is disabled, this option will become unavailable and appear as greyed out in the menu.

## Power Up Settings

**Power Up Mode:** Configures the power up mode preference. **Always On**, **Standby**, and **Last State** options are available.

**Power Mode:** If this feature is enabled the Display can be turned on again with the RS232 and LAN commands if it is turned off through it. Press **OK** to enable or disable the feature.

Enabled - Reactive mode

Disabled - Eco mode

**Power On Delay:** Sets a delay value at power on. This value can be set from 0 to 2000 ms in steps of 100 ms. The Display will turn on after the set delay time has expired.

**Auto Launch:** Configures the auto launch preference. **Disabled**, **HTML5 CMS Launcher**, **Open Browser**, **VsignLite**, **Select Source**, and **Select Application** options are available.

**HDMI Wake Up Enabled:** This feature works based on HDMI 5V signal and it will only work with a single HDMI source. When this signal is active the Display wakes up and when the signal is inactive the Display shuts down. Set to **5V** to enable. In order to use this feature in conjunction with the Auto Source Switch feature, it is recommended to enable the **Auto Source Switch** option in the **Signage Settings > Controls** menu.

If any Scheduler is set, this option will be inactive and cannot be enabled.

**Note:** Depending on the model of your Display, this feature may not be available, or if the **Power Mode** option is disabled (Eco mode), it may not work with the HDMI2 source.

## USB

**Clone to USB:** Copies the database files from the Display to a connected USB device.

**Clone from USB:** Copies the database files from a connected USB device to the Display.

**USB Operations:** Highlight and press **OK** to perform USB operations.

**USB Information:** Press **OK** to open the **USB Information** menu. Current total space and free space information of the connected USB device will be displayed. You can also format the connected USB device as device storage using the **Format Disk** option in this menu (FAT32 format only) to extend the storage capacity of your Display. After doing this, that device will only be usable with the Display.

**IMPORTANT:** Formatting your USB storage device will erase ALL the data on it and its file system will be converted to FAT32.

**USB Option:** Set to **Off** to disable the USB ports on the Display. You can also set this option to **5V** to provide 5 volts power over USB. In this case it will still not be available to browse the USB content via the Media Player feature of the Display.

**Safely Remove:** You can use this option to remove the devices connected to the USB inputs of the Display safely. Highlight this option and press **OK**. Wait for the message to be displayed on the screen and then remove your device. Failure to do so, may cause problems when you connect your USB device to other devices and you might have to format your USB device.

## OPS Settings

Press **OK** to open the **OPS Settings** menu screen. This menu cannot be displayed if the OPS module is not plugged in.

**OPS Status:** Displays whether the OPS module is on or off. Allows the change of status via soft PSON signal (0.5s).

**OPS Power:** Highlight and press **OK** to turn the OPS module on or off.

**Power Down:** Turns the OPS off via hard PSON signal (5s).

**Boot Signal:** Enables or disables sending of a PSON signal. The Display checks the status signal of the OPS at bootup in order to turn it on by sending a PSON signal if it is off. Some OPS's send incorrect information on their status during the bootup of the Display, so they seem to be on even though they are off. For such non-standard OPS's, this option must be enabled. In this case, a PSON signal will be sent for the OPS regardless of the received status information at bootup.

**Recovery Mode:** When this option is enabled and OPS is on, if there is no video for 10 seconds it resets hotplug. If there is no video available after 30 seconds it reboots OPS.

**OPS Always On:** When this option is enabled, the **Power Mode** option in the **Display Settings > Signage Settings > Power Up Settings** menu will be forced to enabled (**Reactive** mode) and greyed out in the menu and OPS will not be set to standby.

### Scheduler Settings

Using the scheduler options you can set the Display to turn on automatically at defined time intervals with the defined input source setting on the desired days of the week. Press **OK** to open the **Scheduler Settings** menu. You can set up to 4 different plans.

Highlight the desired plan option and press **OK** to set. Now you will be able to define a time for the Display to be turned on automatically. Highlight the related option and press the **OK** button, then use the directional and numeric buttons on the remote to set a time. Highlight **OK** and press the **OK** button again when you are done.

Perform the same steps to set a time for the Display to turn off.

Next, select the week day/s for your plan to be activated. Highlight the desired day/s and press **OK** to check. Highlight and press **OK** a second time to uncheck a box. The plan will be active on the checked days of the week.

Then define a source for your plan. Highlight the related option and press the **OK** button, then set as desired using the Up/Down directional buttons and the **OK** button. If the **Last Source** option is selected, the input source will not be changed at the power-up. If the **USB** option is selected, the media files on the connected USB device will be automatically played back as explained in the **USB Auto Play Feature** section.

In order to select one of the applications installed on the Display for your plan, highlight **Select Application** and press **OK**. Available applications will be listed. Highlight the application of your choice and press **OK** to select. The selected application will run for the defined period of time.

You can also set backlight on and off values for your plan. Highlight **Backlight** and press **OK**. Then highlight the backlight sliders and set using the Left/Right directional buttons. These values will be used to adjust the backlight of the Display at the beginning and at the end of the plan. Mind that, in case you set only the backlight sliders, the display will not be turned on or off, only the backlight values will be changed at defined time interval. If the source option is set to **Last Source**, the backlight settings will be applied to all sources, otherwise the settings will be applied to the selected source only.

You can use the **Plan Enable** option to enable or disable the current plan. When the plan is enabled, the **Save** option will appear on the plan setting screen. Highlight it and press **OK** to save settings when complete.

You can use the **Reset** option to reset all settings.

### Link Options

Press **OK** to open the **Link Options** menu. Current **Start url** and **Settings url** links will be displayed. These items are for information only and not selectable. Refer to the **Changing the Start and Settings URL's** section for information on setting these links. The **Open browser initial page** and **NTP server** link preferences can be configured using the related options. Highlight the option you want to configure and press **OK**.

**Open browser initial page:** Sets the initial page link for the open browser.

**NTP server:** Sets the NTP server link.

**Start url:** Displays the Start URL link.

**Settings url:** Displays the Settings URL link.

### Volume Settings

**Volume Limit:** Sets the maximum value of the volume.

**Volume Limit (Headphone):** Sets the maximum value of the headphone volume.

**Startup Volume Enable:** Enables or disables the use of startup volume value which is set in the **Startup Volume Value** menu item. If this option is disabled, this menu item will be unavailable to be set. Press **OK** to enable or disable the feature.

**Startup Volume Value:** Sets the startup value of the volume.

**Fixed Volume Enable:** Enables or disables the use of fixed volume value which is set in the **Fixed Volume Value** menu item. Press **OK** to enable or disable the feature.

**Fixed Volume Value:** Sets the value of the volume to be fixed.

**Headphone Direct Volume:** When this feature is enabled, the sound is routed directly to the headphone output, without going through the Display's sound processing procedures.

## Video Wall Settings

**Video Wall Settings:** Enables or disables the video wall function. Press **OK** to enable or disable.

**Row Count:** Adjusts the number of Video Wall "rows". Use the Left and Right directional buttons to set. The maximum number that can be set is 10.

**Column Count:** Adjusts the number of Video Wall "columns". Use the Left and Right directional buttons to set. The maximum number that can be set is 10.

**Cell:** Each Video Wall unit is called "Cell". This option is used to adjust your Display's cell number. Use the Left and Right directional buttons to set. The maximum number that can be set is 100. In order to disable the video wall function of the unit and display the image in full-screen mode, this option should be set to 0.

**Offset:** Adjusts the refractions at the sides of the picture depending on the bezel thickness between the Video Wall units (Cells). Use the Left and Right directional buttons to set. The maximum number that can be set is 50.

**Reset:** Resets the settings to factory defaults.

### Reset to Default Values

**Reset:** Highlight this option and press the **OK** button on the remote to return the signage menu settings to factory defaults.

### First time installation

Highlight this option and press **OK** to repeat the initial setup process and reset the Display's settings to the factory defaults.

You will be asked to enter the PIN that you have defined during the initial setup process. If you didn't define a PIN during the initial setup, you can use the default PIN. Default PIN is set to **0000**.

## System Settings

**Language:** Set your OSD menu language preference.

**Date/Time:** Set the date and time options of your Display.

**Automatic date & time:** You can set your Display to automatically update the time and date data over the network. Turn this option off, if you want to manually set the date and time.

**Set date:** Set the date manually.

**Set time:** Set the time manually.

**Set time zone:** Set the time zone.

**Use 24-hour format:** Turn the 24-hour format on or off.

**Sources:** Enable or disable selected source options. There will be **Disabled**, **Enabled**, and **Enhanced** options available for HDMI sources, if your Display supports Ultra HD. The **Enabled** and **Enhanced** options are affecting the colour settings of the selected HDMI source. To be able to watch 4K images from an HDMI source related source setting should

be set to **Enhanced** if the connected device is HDMI 2.0 compatible. Set to **Enabled** if the connected device is HDMI 1.4 compatible. Set accordingly or disable the related HDMI source by setting to **Disabled**.

**Note:** HDMI cables which are longer than 5 metres and which are not HDMI certified can cause display problems. We recommend using a certified Premium High-Speed HDMI Cable. Source device, connection cable quality and other HDMI equipments used may affect performance.

Please refer to % <https://www.hdmi.org/resource/cables> (for finding the right cable)

### More

**Internet Speed Test:** Start a speed test for the Internet connection. The test result will be displayed when completed.

**Menu Timeout:** Set your idle timeout duration preference for the menus.

**Standby Mode Led:** Enable or disable the functionality of the standby mode LED. If set to **Off** the standby mode LED will not light up when the Display is in standby mode.

**Software Upgrade:** Ensure that your Display has the latest software. Press **OK** to see the current software version and last update time. The **CHECK UPDATE** option will be highlighted. You can start a manual search for an update by pressing **OK**. To do this, your Display should be connected to the Internet. If any update is found, you can download and install the new software using the related options. Follow the on-screen instructions to complete the process.

**Auto Software Upgrade:** Enable or disable the automatic software upgrade functionality. **On** and **Off** options will be available. Set according to your preference.

**Country:** The country that was selected during the initial setup process will be shown.

**Auto Display Off:** Set your time preference for the Display to automatically go into standby mode when not being operated. This option can be set from 1 to 8 hours in steps of 1 hour. You can also disable this option by setting to **Off**.

**CEC:** Enable or disable the CEC functionality. Highlight the option of your choice and press **OK** to set.

**CEC Auto Power On:** This function allows the connected HDMI-CEC compatible device to turn on the Display and switch to its input source automatically. Highlight the option of your choice and press **OK** to set.

**USB Auto Play:** Using this option you can set your Display to start playing the media content installed on a removable device automatically. Refer to **USB Auto Play Feature** section for detailed information.

## Operating System Settings

### Menu Content

You can also configure some of the settings of your Display via the hidden operating system's **Settings** menu. In order to access this menu, press the **Menu** button and then the **3-2-9-1** numeric buttons on the remote consecutively. Available options will be listed.

### Network & Internet

You can configure your Display's network settings using the options of this menu. Refer to the **Display Settings Menu Content** section for more information.

### Apps

Using the options of this menu, you can manage the apps on your Display.

### Recently opened apps

You can display recently opened apps. Highlight **See all apps** and press **OK** to see all the apps installed on your Display. The amount of storage space that they need will also be displayed. You can see the version of the app, open or force to stop the running of the app, uninstall a downloaded app, see the permissions and turn them on/off, turn on/off the notifications, clear the data and cache, etc. Highlight an app and press **OK** to see available options.

### Permissions

Manage the permissions and some other features of the apps.

**App permissions:** The apps will be sorted by permission type categories. You can enable/disable permissions for the apps from within these categories.

**Special app access:** Configure some app features and special permissions.

### Device Preferences

**About:** Check for system updates, change the device name, restart the Display and view system information such as network addresses, serial numbers, versions, etc. You can also view legal information here.

**Date & Time:** Set the date and time options of your Display. You can set your Display to automatically update the time and date data over the network. Set corresponding to your environment and preference. Disable by setting as **Off** if you want to manually change the date or time. Then set the date, time, time zone and hour format options.

**Keyboard:** Select your keyboard type, configure remote controller input method preferences, and manage keyboard settings.

## Sound

**System Sounds:** System sound is the sound played when navigating or selecting an item on the Display screen. Highlight this option and press **OK** to turn this function on or off.

### Surround Sound

Select your preference for the surround sound feature.

**Select formats:** Highlight this option and press **OK**. **Auto**, **None**, and **Manual** options will be available. Highlight the option you prefer and press **OK** to set.

**Storage:** View the total storage space status of the Display and connected devices if available. To see detailed information on the usage details highlight and press **OK**. There will also be options for ejecting and setting up the connected USB storage devices as device storage.

**Migrate data to this storage:** This option will appear if you did priorly format your USB storage device as device storage. You can use this option to migrate some of the data stored on your Display to your USB storage device.

**Note:** If you move data to your USB storage device, you may need to plug in your storage device to use all your apps and other content.

**Eject:** To keep your content safe, eject your USB storage device before you unplug it from your Display.

**Erase & format (Set up) as device storage:** You can use the connected USB storage device to extend the storage capacity of your Display. After doing this, that device will only be usable with the Display. Follow the on-screen instructions and read the information displayed on the screen before proceeding.

**Note:** Formatting the connected storage device will erase all data installed on it. Back up the files that you want to keep before you proceed with formatting the device.

**Erase & format (Set up) as removable storage:** If you did priorly format your USB storage device as device storage, it will only be usable with your Display. You can use this option to format it again in order to use it with other devices. Before proceeding with the formatting, you may consider backing up the data on your device to your Display's internal storage or to another USB storage device using the **Back up apps** option. Otherwise, some apps may not work properly after formatting. Follow the on-screen instructions and read the information displayed on the screen before proceeding.

**Note:** Formatting the connected storage device will erase all data installed on it. Back up the files that you want to keep before you proceed with formatting the device.

**Screen Saver:** Set the screensaver and sleep mode options for your Display. You can choose a screensaver, set wait time for the screensaver, set when the Display goes into sleep mode or start the screensaver mode.

**Location:** You can allow the use of the wireless connection to estimate the location, see the recent location requests

and allow or restrict the listed apps to use your location information.

**Security & restrictions:** Using the options of this menu;

- You can allow or restrict installation of apps from sources other than the Google Play Store.
- Set the Display to disallow or warn before installation of apps that may cause harm.

**Accessibility:** Configure the **Captions, Text to speech, Accessibility shortcut** settings and/or turn **High-contrast text** on/off. Some of the caption settings may not be applied.

**Reset:** Reset all Display settings to the factory defaults. Highlight **Reset** and press **OK**. A confirmation message will be displayed, select **Reset** to proceed with resetting. The Display will switch off/on first and the initial setup will start. Select **Cancel** to exit.

## Bluetooth Remotes & Accessories

You can use wireless accessories, such as remote controls, headphones, keyboards or game controllers with your Display. Refer to the **Signage Settings** section for detailed information.

If the **Bluetooth** option in the **Display Settings > Signage Settings > Controls** menu is disabled, this option will not be available.

## Installing Third Party Applications

Follow the below mentioned steps in order to install a third party application.

- Copy the file with the extension “.apk” onto a FAT formatted USB storage device
- Connect the USB storage device to one of the USB inputs on the Display.
- Launch the **AppInstaller** app from the **Applications** menu on the Home Screen. Highlight your connected USB storage device on the next dialogue and press **OK** to search the content for apk files. Highlight one of the found files and press **OK**. Your permission will be asked. Highlight **INSTALL** and press **OK** again to proceed.
- You can access the installed applications from the Applications menu on the Home Screen.

**Note:** Third party applications support is limited. Some functions of the application or properly launch may be affected as not being coded.

## Connectivity

To configure wired and wireless settings you should access the **Display Settings > Network & Internet** menu. Press the **Menu** button on the remote to view the **Display Settings** menu.

## To Connect to a Wired Network

There is an Ethernet socket on the rear side of your Display. Connect your Display to your modem/router via this Ethernet socket using an Ethernet cable. Refer to the **General View** section on the first pages of this manual to see the location of the socket.

The status of the Internet connection under the **Ethernet** caption in the **Network & Internet** menu will read ‘Connected’. The MAC and IP addresses will also be displayed under this caption. You can also set a proxy server and change the IP settings using the related options.

**Note:** The IP Setting changes will not take immediate effect but becomes active after the Display is turned off and then back on again.

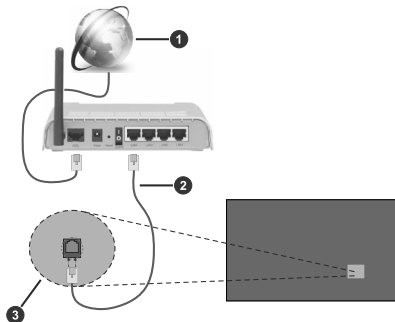

- 1 Broadband ISP connection
- 2 Ethernet (LAN) cable
- 3 Ethernet (LAN) input (on the rear side of the Display)

## To Connect to a Wireless Network

A wireless LAN modem/router is required to connect the Display to a wireless network. If the Display is connected to a wired network, unplug the Ethernet cable to allow wireless connection.

Highlight the **Wi-Fi** option in the **Network & Internet** menu and press **OK** to turn on the WLAN. Available networks will be listed. Select one and press **OK** to connect. You may be asked to enter a password to connect to the selected network, in case the network is password protected.

You can see the status of the connection under the name of your network. It will read ‘Connected’ if the connection is successful. Highlight your network under the **Available networks** caption in the **Network & Internet** menu and press **OK** to see the detailed information on the connection such as MAC and IP addresses. This way you can also access advanced settings for the wireless connection such as proxy and IP settings. You can also use the **Forget network** option here to delete the connected wireless network profile, so the Display will not connect to that network automatically if it is available when the WLAN option is turned on.

**Note:** The IP Setting changes will not take immediate effect but becomes active after the Display is turned off and then back on again.

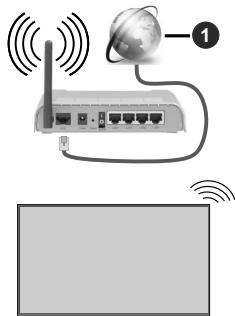

### 1 Broadband ISP connection

A network with hidden SSID (network name) can not be detected by other devices. If you want to connect to a network with hidden network name, highlight the **Add new network** option under the **Other options** caption and press **OK**. To connect to the network, enter its name, select the type of security and then enter the password if it is password-protected. You can also make your network's name visible by changing the settings via the modem's software.

A Wireless-N router (IEEE 802.11a/b/g/n/ac) with simultaneous 2.4 and 5 GHz bands is designed to increase bandwidth. These are optimised for smoother and faster HD video streaming, file transfers and wireless gaming.

The frequency and channel differ depending on the area.

The transmission speed differs depending on the distance and number of obstructions between the transmission products, the configuration of these products, the radio wave conditions, the line traffic and the products that you use. The transmission may also be cut off or may get disconnected depending on the radio wave conditions, DECT phones or any other WLAN 11b appliances. The standard values of the transmission speed are the theoretical maximum values for the wireless standards. They are not the actual speeds of data transmission.

The location where the transmission is most effective differs depending on the usage environment.

The Wireless feature of the Display supports 802.11 a,b,g,n & ac type modems. It is highly recommended that you should use the IEEE 802.11n communication protocol in order to avoid any possible problems while watching videos.

You must change your modem's SSID when there are any other modems around with the same SSID. You can encounter connection problems otherwise. Use a wired connection if you experience problems with a wireless connection.

A stable connection speed is required to play back streaming content. Use an Ethernet connection if the wireless LAN speed is unstable.

**Note:** Operating system allows only one network connection at a time. If the Display is connected to the network both wirelessly

and via Ethernet (wired), the Ethernet connection will take priority. Since if this is the case, a WLAN connection can not be established. Unplug the Ethernet cable to allow wireless connection.

## Networked Standby Mode

Networked Standby Mode is a standard that allows a device to be turned on or woken up by a network message (magic packet). This message is sent to the device by a program executed on a remote device connected to the same local area network, such as a smartphone.

To enable this feature the **Networked Standby Mode** option in the **Network & Internet** menu and the **Power Mode** option in the **Display Settings > Signage Settings > Power Up Settings** menu should be enabled (**Power Mode - Reactive**). It is necessary that both the device, from which the network message will be sent to the Display, and the Display are connected to the same network. All devices must support magic packet on the system from Access Points to the device which sends the magic packet and the device which receives the magic packet to wake-up. You can use any Networked Standby Mode software available for the operating system of your device in order to send magic packets.

In order to use this feature the Display and the remote device should be connected at least once while the Display is on. If the Display is powered off, the connection should be re-established, the next time it is switched on. Otherwise this feature will be unavailable. This does not apply, when the Display is switched into the standby mode.

### How to control functionality

- Enable the **Networked Standby Mode** feature from within the **Network & Internet** menu
- Connect your Display and the remote device, which will send the magic packets to the Display, to the same network
- Get the MAC address of your Display which will be needed in order to send magic packets. Refer to **Connectivity** section for information on how to get the MAC address
- Switch the Display into standby mode
- Send magic packets to the MAC address of your Display by using mobile phones, Linux or Windows computers

Your Display should wake up after receiving magic packets.

## APPS

You can access the applications installed on your Display from the **Applications** menu on the Home Screen. The Display will open with the Home Screen if the **Auto Launch** option (to be found in the **Display Settings > Signage Settings > Power Up Settings** menu) is set to **Disabled**. Press the **Back/Return** or **Exit** button to display or return to the Home Screen. Highlight **Applications** and press **OK**, then highlight an app and press **OK** to launch.

**Notes:**

Possible application dependent problems may be caused by the content service provider.

Third party internet services may change, be discontinued or restricted at any time.

## Internet Browser

To use the internet browser enter the **Applications** menu on the Home Screen first. Then launch the **Vewd Browser** application. EULA (End User Licence Agreement) confirmation dialogue will be displayed. You can read the entire text using the Up and Down directional buttons. Highlight **Accept** and press **OK** to confirm and proceed.

In the initial screen of the browser, the thumbnails of the predefined (if any) links to web sites available will be displayed as **Speed Dial** options along with the **Edit Speed Dial** and the **Add to Speed Dial** options.

You can press the **Internet** button on the remote to open the internet browser. If the **Open browser initial page** link in the **Display Settings > Signage Settings > Link Options** menu is defined, the browser will open on this page.

To navigate the web browser, use the directional buttons on the remote or a connected mouse. To see the browser options bar, move the cursor to the top of the page. **History**, **Tabs** and **Bookmarks** options and the browser bar which contains previous/next buttons, the refresh button, the address/search bar, the microphone (non-functional), the **Speed Dial** and the **Vewd** buttons are available.

To add a desired website to the **Speed Dial** list for quick access, move the cursor to the top of the page. The browser bar will appear. Highlight the **Speed Dial** -  button and press the **OK** button. Then select **Add to Speed Dial** option and press the **OK** button. Fill in the blanks for **Name** and **Address**, highlight **OK** and press the **OK** button to add. Whilst you are on the site you wish to add to the **Speed Dial** list, highlight the **Vewd** button and press the **OK** button. Then highlight the **Add to Speed Dial** option in the submenu and press the **OK** button again. **Name** and **Address** will be filled automatically according to the site you are visiting. Highlight **OK** and press the **OK** button to add.

You can also use the **Vewd** menu options to manage the browser. Highlight the **Vewd** button and press the **OK** button to see available page specific and general options.

There are various ways to search or visit websites using the web browser.

Enter the address of a website(URL) into the search/address bar and highlight the **Go** button on the virtual keyboard and press the **OK** button to visit the site.

Enter keyword/s into the search/address bar and highlight the **Go** button on the virtual keyboard and press the **OK** button to start a search for the related websites.

Highlight a Speed Dial thumbnail and press the **OK** button to visit the related website.

Your Display is compatible with USB keyboard/mice. Plug your device into the USB input of your Display for easier and quicker navigation.

Some web pages include flash content. These are not supported by the browser.

Your Display does not support any download processes from the internet via the browser.

All sites on the internet might not be supported. According to the site; content problems may occur. In some circumstances video contents might not be able to be played.

## Vsign Lite

Vsign Lite is a signage application runs without CMS and managed through the Display. The Display software is integrated with it.

### 1. Setup

#### Application Specification

Requirements	
Display Platform	MB450VS
Firmware Version	v7.42 & higher versions
Language Options	English, Turkish
Hardware Requirements	USB

#### How is it opened?

During the Display's initial setup process, the **Auto Launch** option should be set to **VsignLite**. Later, every time the Display restarts, the application will open. Additionally this setting can be changed using the **Auto Launch** option in the **Display Settings > Signage Settings > Power Up Settings** menu. You can also launch this application from within the **Applications** menu on the Home Screen.

### 2. Vsign Application Display

The Vsign Lite application consists of three main parts. These are **Player**, **Schedule** and **Template** sections. Moreover, there is the **Import/Export Settings** section for backup/export of application settings.

#### Player

Using this screen, the content of the connected USB storage device or the Display's internal storage can be viewed, erased, played, and transferred to another USB storage device or the Display's internal storage. Various filtering and sorting operations can be done from the menu section above. In addition, the channels created in the section over time are played here.

#### 2.0.1. File Management

Pressing the **OK** button on any file opens the menu for file-related operations. The options described below can be selected and processed.

**Play:** If the selected file is playable, it plays, otherwise the text is dimmed.

**Select:** Selecting the file activates the multi-selection mode described in the next section.

**Send:** Sends the selected file to another storage device or the Display's internal storage.

**Delete:** Deletes the selected file.

### 2.0.2. Multi-Selection Mode

Multiple selection mode is activated by pressing the **OK** button on the **Select** option in the file management menu. Then select the files you want with the **OK** button or cancel the selected ones. During this process, you can go to different folders and select the files there.

Options appear up when multi-selection mode is on. These operations can be done to the selected files as explained below.

**Select All:** Selects all files in the current folder.

**Clear All:** Clears all selected options.

**Play All:** Plays the selected files in order of selection. Appears as greyed out if the files are not playable.

**Send All:** Sends the selected files to the selected USB storage device or the Display's internal storage.

**Cancel:** Closes the multi-selection mode.

#### Schedule

By using the Schedule screen, a channel can be created, programmes can be created within the channel, they can be viewed and edited. The channels number are limited to four.

In the menu, the channels are displayed on the screen in accordance with the time information on the top left and down. With navigation, it can be switched through programmes. Detailed information about the focused programme can be found on the right-hand panel.

#### 2.0.1. Channel/Programme Addition

Navigate to an empty or occupied area and press the **OK** button. In the empty area, channel and programme addition screen, in the occupied area editing screen are opened. Images, videos and templates can be added to the channel as content.

-If the rightmost space (Add Channel) is selected, a new channel will be created and the screen will pop up to create our first programme.

-If an empty space is selected in a previously created channel, the new programme is added to the channel.

-If the occupied area is selected in a previously created channel, the selected programme will be edited.

#### 2.0.1.1. Channel/Programme Editing Screen Input Fields

**Add Content:** If the **OK** button is pressed on this field; the appropriate content is listed. The users can do multi-selection. You can then delete the content by pressing the **OK** button.

**Start Time:** Starting time of the programme.

**Stop Time:** Stopping time of the programme.

**Channel Name:** The name of the channel in which the programme is included.

**Storage:** The storage device in which the channel is saved.

#### 2.0.2. Supported Files

The application supports the formats listed below:

**video:** mp4, mpeg, avi, mov, webm, ts, mpg, m4a, mkv

**image:** jpg, jpeg, png, bmp

#### Template

This screen displays the predefined templates and the user fills them and prepares them for use. User-created templates are kept in the **My Templates** folder. They can be played, edited and deleted from here.

#### 2.0.1. Creation of the Templates

Scroll to one of the previously defined templates and press **OK**. When the **OK** button is pressed on the zones, the compatible content in the memory is listed. Single or multiple selections can be made here. The template can be previewed with the **Preview** button on the right hand side of the screen. Use the **Save** button to save the template.

#### 2.0.1.1. Add Content to Templates Input Fields

**Template Duration:** The length of time that the template will be displayed in a programme cycle.

**Content Duration:** Specifies the amount of time a content will be displayed in the selected area via the template.

**Template Name:** Specify a name for the template.

**Aspect Ratio:** If the area on the template accepts the image, this setting determines whether the aspect ratio of the image is maintained or changed to fill the area.

**Sound:** If there is a field that accepts video in the template, it determines whether the video will sound or not.

#### Import/Export Settings

Using this menu, the Display settings can be transferred to another Display.

#### Switch to Vsign Lite Portrait Orientation

The user can rotate the screen 90 degrees clockwise or counterclockwise by selecting **Portrait1** or **Portrait2** using the **OSD Orientation** in the **Display Settings > Signage Settings > Controls** menu. The application will be rotated vertically.

## Media Player

Highlight **Media Player** on the Home Screen and press **OK** to launch the app. You can also press the **Media Player** button on the remote for quick access. Select the media type on the main media player screen.

#### Image Files

Press **OK** to display the highlighted photo file. On the upper left and right of the screen some options will be available. Using these options you can sort or group the files, change the viewing style, start a slideshow, etc. You will also be



able to select the files, then make the selected files available offline, share them via short-range wireless connection (depends on the model), rotate left/right or refresh the screen or access more settings using the related options.

When you start a slide show, all photo files in the current folder will be displayed in an infinite loop. Press the **OK** or **Back/Return** button to stop the slide show.

## Music Files

You can use the tabs at the top of the screen to sort the files. Press **OK** to play back the highlighted music/audio file. Now Playing screen will be displayed. You can use the options here to control the media.

### The Media Control Buttons on the Now Playing Screen

**Play List:** Display the now playing playlist.

**Shuffle:** Highlight and press **OK** to turn the shuffle option on or off. When the shuffle mode is on, all of the music files in the current playlist are played in a random order.

**Repeat:** Highlight and press **OK** to turn on or off the repeating option for the playing file or all files in the current playlist. Press **OK** consecutively to change the functionality. All music files in the current list or the currently playing file will be repeatedly played back.

**Pause/Play:** Highlight and press **OK** to pause and resume the playback.

**Start from beginning/Previous File:** Highlight and press **OK** to start the playback from the beginning or switch to the previous file in the list.

**Next File:** Highlight and press **OK** to switch to the next file in the list.

**Playback Progress Bar:** Highlight and use Left/Right directional buttons to fast forward or rewind the playback.

## Video Files

Select the drive as **Local Disk** or the connected USB storage device. Highlight a video file and press **OK** to play it back. You can use the buttons on the info bar to control the video playback, and configure the settings. The info bar will disappear after a certain period of time. Press **OK** to reveal the info bar again.

Press the **Back/Return** button to stop the playback and return to the media player screen.

## From USB Connection

**IMPORTANT!** Back up the files on your USB storage devices before connecting them to the Display. Manufacturer will not be responsible for any file damage or data loss. Certain types of USB devices (e.g. MP3 Players) or USB hard disk drives/memory sticks may not be compatible with this Display.

You can view your photos, text documents or play your music and video files installed on a connected USB storage device on the Display. Plug in the USB storage device to one of the USB inputs on the Display.

On the main media player screen select the desired media type. Then, highlight a media file and press the **OK** button. Follow the on-screen instructions and see the related sections above for more information on other available button functions.

**Note:** Wait a little while before each plugging and unplugging as the player may still be reading files. It is recommended to use the **Safely Remove** option in the **Signage Settings > USB** menu or the **USB Safely Remove** option in the File Manager application. Failure to do so may cause physical damage to the USB player and the USB device itself. Do not pull out your drive while playing a file.

## USB Auto Play Feature

This feature is used to start playing the media content installed on a removable device automatically. It uses the Media Player application. The media content types have different priorities in order to be played. The reducing priority order is as Photo and Video. That means, if there is Photo content in the root directory of the removable device, Media Player will play the Photos in a sequence (in file name order) instead of Video files. If not, it will be checked for Video content.

This feature will only work if all of the following circumstances occur:

- The USB device is plugged in.
- The **USB Auto Play** option is enabled. It can be found in the **Display Settings > System Settings > More** menu.

## CEC and CEC RC Passthrough

This function allows to control the CEC-enabled devices, that are connected through HDMI ports by using the remote control of the Display.

The **CEC** option in the **Display Settings > System Settings > More** menu should be set to **Enabled** at first. Press the **Source** button and select the HDMI input of the connected CEC device from the **Source** menu. When a new CEC source device is connected, it will be listed in the source menu with its own name instead of the connected HDMI port's name (such as DVD Player, Recorder 1, etc.).

The Display remote is automatically able to perform the main functions after the connected HDMI source has been selected. To terminate this operation and control the Display via the remote again, press and hold the "0-Zero" button on the remote control for 3 seconds.

You can disable the CEC functionality by setting the related option under the **Display Settings > System Settings > More** menu accordingly.

The Display also supports the ARC (Audio Return Channel) feature. This feature is an audio link meant to replace other cables between the Display and an audio system (A/V receiver or speaker system).

When ARC is active, the Display does not mute its other audio outputs automatically. You will need to decrease Display volume to zero manually if you wish to hear the ARC audio only (same as optical or co-axial digital audio

outputs, availability depends on the model). If you want to change connected device's volume level, you should select that device from the source list. In that case volume control keys are directed to connected audio device.

## System Audio Control

Allows an Audio Amplifier/Receiver to be used with the Display. The volume can be controlled using the remote control of the Display. To activate this feature set the **Speakers** option in the **Display Settings>Sound** menu to **External audio system**. The Display speakers will be muted and the sound of the watched source will be provided from the connected sound system.

**Note:** The audio device should support System Audio Control feature and **CEC** option should be set to **Enabled**.

## Changing the Start and Settings URL's

- Create a file named "starturl.txt" or "settingsurl.txt" in the root directory of any USB storage device. Make sure that the extension is ".txt".
- Open this file with a text editor software such as Notepad.
- Write the desired URL (for example, www.starturl.com) in the file and save changes.
- Connect the USB storage device to the Display. Highlight the **USB Operations** option in the **Display Settings > Signage Settings > USB** menu and press **OK**.
- Set the **Auto Launch** option in the **Display Settings > Signage Settings > Power Up Settings** menu to **HTML5 CMS Launcher**.

**Note:** You can check if the Start URL or Settings URL have the desired link from the **Display Settings > Signage Settings > Link Options** menu.

## HTML5 CMS Launcher

The launcher locates the "index.html" file in the folder that is specially created for the CMS files on the Display's internal storage and opens it in the web browser.

For trouble-free operation of the CMS launcher, the storage permission should be enabled for the Vewd browser first. Press the **Menu** button and then the **3-2-9-1** buttons on the remote consecutively to access the hidden Operating System Settings menu. Enter the **Storage** category in the **Apps > App permissions** menu, highlight the option for the Vewd browser and press **OK** to enable.

Highlight **HTML5 CMS Launcher** on the Home Screen and press **OK**. The **Launcher** and **Settings** options will be available.

### Launcher

You can activate the CMS launcher using this option.

## Settings

You can install new CMS files using one of the two available options, or delete the previously set URL and installed CMS files.

**Install from URL:** The compressed CMS file is uploaded as a URL. Enter the URL of the file, highlight **OK** and press **OK**. The file will be downloaded and then extracted to a dedicated folder on the Display's internal storage.

**Install from USB:** The compressed CMS file is installed onto a USB storage device. The file should be named "cms.zip". Connect a USB storage device to the Display that contains the cms file, then highlight this option and press **OK**. The connected USB device will be checked for available files. The file will be downloaded and then extracted to a dedicated folder on the Display's internal storage.

**Return to Factory Settings:** The previously set URL and installed CMS files will be deleted.

## OSD Rotation Support

You can change the OSD (On-Screen Display) rotation of your Display if desired. While performing initial setup set the **OSD Orientation** option as desired when the **Signage Settings** menu is displayed. You can also change this setting later from the **Display Settings > Signage Settings > Controls** menu. Available options are: **Landscape**, **Portrait1**, **Portrait2**, and **Auto**.

When set to **Auto**, the Display will use the integrated gyro sensor to detect its current rotation automatically and change the OSD orientation accordingly. The integrated gyro sensor and the **Auto** option may not be available depending on the model of your Display and its features.

**Note:** Each time the OSD orientation is changed from portrait to landscape or vice versa, the Display should be turned off (standby mode) and then back on.

## HDMI Out

The HDMI port located on the rear left side of the Display functions as an output port (upper HDMI port, HDMI Out). This port will not function as an input, thus no source devices should be connected to this port. Only the content received from the HDMI1 input port located also on the rear left side of the Display (the one under the HDMI Out port) can be outputted from this port. The content received from other inputs, such as HDMI2, can not be outputted. This is a default function and you can not disable/enable through any menu option. HDMI Out port will always function if a source device is connected to the HDMI1 input.

## Real Time Clock (RTC)

Your Display has an RTC. It is used to maintain the real date and time information for a period of time if the energy supply is interrupted by separating the Display from the

mains or by a power blackout. In this case the Display will use the date and time information stored in RTC.

- All time sources are able to override RTC date/time.
- Display tries to connect to the **NTP server** periodically (6 hours after last update) to get the current date and time information. If the Display successfully gets this information from the NTP server, it updates itself and RTC with the received date and time information. If the NTP server update fails, the Display uses RTC time and date to update itself.
- The RTC battery provides power to the integrated real-time clock and the calendar. Without any external power source, RTC is able to function for a minimum of 14 days.
- If RTC is used as time source, manual date-time set is enabled from the **Date/Time** option in the **Display Settings > System Settings** menu.

## Crestron Connected

In order to work with Crestron Connected protocol, "CrestronConnected" profile option should be enabled.

Flash UI which is served by the display device is not supported. Flash UI which is served by the control system can be used. Flash UI will not be directly connected to display device but will be connected indirectly over control system in this case.

Widi source is not visible to the Crestron Connected interfaces (e.g. Roomview, Xpanel). The reason is when we select this source the connection is broken and therefore could not communicate with crestron devices again.

Configuration page to set control system ip address/hostname, ip id, and port can be reached by writing the ip address of display to the browser address bar on your computer.

If SecureCommand profile option is enabled, configuration page is opened with a password dialogue. After entering the correct password configuration dialogue appears. Password is the same with the one used in SETUSERSECLEVEL command.

## Controlling With An External PC

You can control the Display from an external PC via RS-232 (COM port) or LAN (Ethernet port) on the PC. For instance, system source can be changed from remote computer. When a command is sent from the PC to the Display, the Display operates according to the received command and sends a response message to the PC.

### Equipment/Tools

- RS-232 (3.5mm) to RS-232 (male) cable or LAN cable (connected via router)
- USB to RS-232 (female) adapter
- Notebook or PC which has USB or LAN port

- Installed program on remote PC to send commands

In general, the commands are sent for operating the implemented functions via serial or LAN port and utility. A suitable utility can be used such as described below.

### Connecting to the Display (RS232 port)

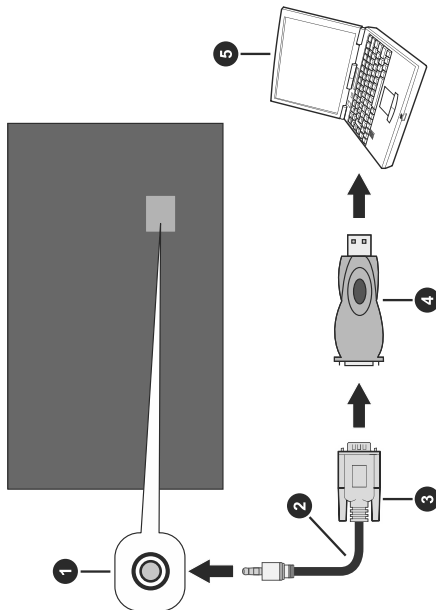

1. RS-232 Input Socket (3.5mm)
2. RS-232 to 3.5mm serial cable (commercially available)
3. To COM port
4. RS-232 to USB adapter
5. PC

Run the software and select **Serial** as **Connection Type**. Enter the Display's serial port in the field **Serial Line** (in the following example it is COM4) and **"115200"** in the field **Speed**. Then click the **Open** button.

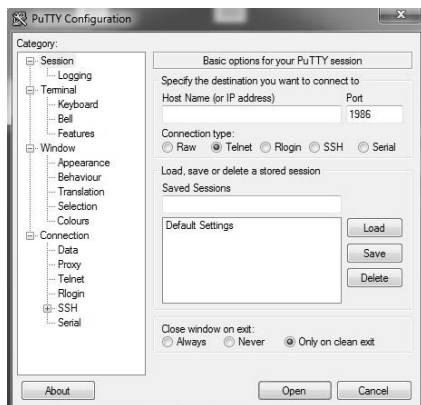
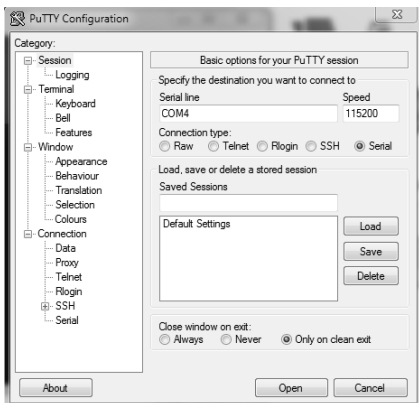

## Connecting to the Display (LAN port)

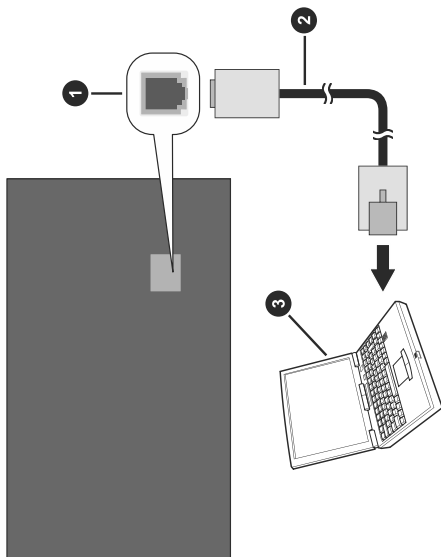

1. Ethernet port
2. Ethernet cable (commercially available)
3. PC

Run the software and enter the Display's IP address in the field **Host Name**. Enter **"1986"** as a default value in the field **Port**. Then select **Telnet** as **Connection type** and click the **Open** button.

**Note:** Refer to the **Connectivity** section of this manual for information on connecting the Display to a network and displaying the IP address of the Display.

## RS232/LAN Command Table

ADMIN PANEL COMMANDS			
Command	Description	Parameter	Return
<b>TOF</b>	Turn off panel	no parameter	#Display will be sent to Active Standby state. or #Display is in Active Standby state already!
<b>RST</b>	Restart	no parameter or int (wait seconds until Restart)	#Display will be restarted
<b>STV</b>	Sets panel Volume, parameter value will ve set for volume level	integer (volume level)	#Volume set level= ...
<b>GTZ</b>	Get Time Zone	no parameter	#Timezone is ...
<b>CTZ</b>	Change Time Zone.	integer (gmt value )	#Timezone setup SUCCEEDED
<b>STL</b>	Set panel Language	string-int (please look at abbreviations of languages)	#Language changed to ... or #Wrong language selection.
<b>SMA</b>	Set mac address Note: This command is not available for MB230 platform. Instead, set_mac_address command can be used. Note2: This command only changes mac address of wired interface. Note3: Reboot needed.	string-int ( ex: eth0-00:09:df:86:34:25)	#SetMacAdress Successful #*FAILURE - Invalid mac address! #*FAILURE - Could not write MAC address!
<b>get_mac_address</b>	Get mac address	none	#*Hwaddr: mac_address - Succesfull
<b>GETMACADDRESS</b>	Gets mac address of selected network interface	none	#*Hwaddr: <mac_address> - Succesfull or #*Mac address could not be obtained
<b>GETGPIO</b>	Gets the GPIO's state	pin number(visit the GPIO List)	#*GPIO level is ...
<b>SETGPIOLOW</b>	Sets the GPIO's state to low	pin number(visit the GPIO List)	#*... is set to HIGH
<b>SETGPIOHIGH</b>	Gets the GPIO's state to high	pin number(visit the GPIO List)	#*... is set to LOW

<b>SELECTSOURCE</b>	Select source.	integer n (7 = HDMI1, 8 = HDMI2, 9 = HDMI3, 10 = HDMI4, 19 = DP, 20 = OPS, 26 = TYPE C )	#*Select external source: ...
<b>SSIP</b>	Set static IP, Default Gateway and SubnetMask addresses (seperate addresses with "-" character)	string ( ex: 192.168.0.15-10.0.90.5-255.255.255.0)	#IP address setting Succesfull

#### AUDIO COMMANDS

Command	Description	Parameter	Return
<b>VOLUME</b>	Set volume level.	integer n ( $0 \leq n \leq 100$ )	#*set volume to n
<b>GETVOLUME</b>	Volume level information.	no parameter	#*volume level is ...
<b>VOLUMEUP</b>	Increase Volume Level by 1 step (Until max volume)	no parameter	#*volume LEVEL is increased to ... or #*Volume level is at max value. You can not increase volume level further. Confirmed max volume level is ...
<b>VOLUMEDOWN</b>	Decrease Volume Level by 1 step	no parameter	#*volume LEVEL is decreased to .. or #*Volume level is at min value. You can not decrease volume level further
<b>SETEQMODE</b>	Set equalizer mode.	string n (Standart, Music, News, Theater, Game, Custom)	#*setEQMode() set to n or #*The above parameter should be one of Standard, Music, News, Theater, Game, Custom.
<b>GETEQMODE</b>	Get equalizer mode	no parameter	#*the equalizer mode is n Note: Above n is one of Standart, Music, News, Theater, Game, Custom
<b>GETMUTE</b>	Get mute status.	no parameter	#*MUTE OFF or #*MUTE ON
<b>SETMUTE</b>	Toggle mute status.	no parameter	#*MUTE OFF or #*MUTE ON
<b>SETBALANCE</b>	Set balance value.	integer n ( $-50 \leq n \leq 50$ )	#*set balance level to n or #*invalid balance level entered
<b>GETBALANCE</b>	Get balance value.	no parameter	#*balance level is ...

<b>SETDYNAMICBASS</b>	Set dynamic bass state.	integer n (0 = off, 1 = on)	#*set dynamic bass state to n
<b>GETDYNAMICBASS</b>	Get dynamic bass state.	no parameter	#*the dynamic bass state is ... (0 = off, 1= on)
<b>SETBASSGAIN</b>	Set bass gain	integer n (-6 <= n <= 6)	#*set bass gain to n or #*Incorrect sound system parameter entered
<b>GETBASSGAIN</b>	Get bass gain	no parameter	#*the bass gain level is n Note: Above n is -6 <= n <= 6
<b>SETSURROUNDSOUND</b>	Set surround sound state.	integer n (0 = off, 1 = on)	#*set surround sound state to n
<b>SOUNDRESET</b>	Reset sound settings	no parameter	#*reset all sound settings

### BROWSER COMMANDS

Command	Description	Parameter	Return
<b>OPENURL</b>	Starts the given URL and returns web page load status directly.	string	#*URL : ...
<b>GETURL</b>	Gets URL of the current page if the portal is active.	no parameter	#*URL : ...
<b>SETSETTINGSURL</b>	Sets the browser settings URL	string	#*Setting URL is set
<b>GETSETTINGSURL</b>	Gets the browser settings URL	no parameter	#*Setting URL is ...
<b>SETSTARTURL</b>	Sets the start URL	string	#*Start URL is set
<b>GETSTARTURL</b>	Gets the start URL	no parameter	#*Start URL is ...
<b>GETUSERAGENT</b>	Gets portal user agent.	no parameter	#*Current UA : ...
<b>CLEARCACHE</b>	Clear browser cache/ cookies (Private datas like web form)	no parameter	#*Browser cookies are cleared
<b>CLEARBROWSERDATA</b>	Clear browser data files like History, Bookmarks, Speed Dial and Configuration	no parameter	#*Browser data files are cleared
<b>GETCMSSTATUS</b>	Gets the CMS status	no parameter	#*Do cms status assignment with SETCMSSTATUS command or Returns the value of cms status
<b>SETCMSSTATUS</b>	Sets the CMS status	string parameter max. length of 255 characters	#*CMS status set to ... or #*NACK

<b>GETCMSPARAMS</b>	Gets the CMS parameters	no parameter	#*Do cms param assignment with SETCMSPARAMS command. or Returns the value of cms params
<b>SETCMSPARAMS</b>	Sets the CMS parameters	string parameter max. length of 255 characters	#*CMS params set to ... or #*NACK
<b>SETBROWSERDEBUG</b>	Sets the browser debug mode	string n (n = ON, n = OFF)	Browser debug is enabled. Open the following url with any chromium-based desktop browser: chrome://inspect or Browser debug is disabled
<b>SETBROWSECORS</b>	Set browser cors status to enable disable web security flag	int n (n = 0,1)	#*Browser cors is enabled or #*Browser cors is disabled
<b>GETBROWSECORS</b>	Get browser cors status	no parameter	#*Browser cors is enabled or #*Browser cors is disabled

#### FILE SYSTEM COMMANDS

Command	Description	Parameter	Return
<b>MP3PLAY</b>	Play MP3 audio file.	string-integer n Example: MP3PLAY audio.mp3	#*Playing audio : n
<b>MP3GETPLAYING</b>	Returns playing audio file.	no parameter	#*Playing /storage/2ECD-304C/audio.mp3
<b>VIDEOPLAY</b>	Play Video file.	string-integer n Example: VIDEOPLAY video.mp4	#*Playing video : n
<b>VIDEOGETPLAYING</b>	Returns playing video file.	no parameter	#*Playing /storage/2ECD-304C/video.mp4
<b>IMGSHOW</b>	Show image file.	string-integer n Example: IMGSHOW picture.jpg	#*Playing video : n
<b>IMAGEGETSHOWN</b>	Returns shown image file.	no parameter	#*Showing /storage/2ECD-304C/picture.jpg
<b>GETDISKFORMAT STATE</b>	Get format state of internal USB disk	no parameter	#*the disk is formatted. or #*the disk is not formatted. or #*No Internal USB is found.
<b>FORMATDISK</b>	Format the internal USB disk as FAT32	no parameter	#*formatting is succesful. or #*error while formatting. or #*No Internal USB is found.

#### GENERAL PANEL FUNCTIONS



Command	Description	Parameter	Return
<b>Led</b>	Turns the led on/off. (Used for setting the led status of current state)	integer n (0 = off, 1 = on)	##*Led is ON or ##*Led is OFF
<b>GETLED</b>	Get led on/off state. (Used for getting the led status of current state)	no parameter	##*LED is on or ##*LED is off
<b>SETSTANDBYLED</b>	Set Standby led status	string n (n = ON, n = OFF)	##*Standby Led is set to ON or ##*Standby Led is set to OFF or ##*Standby Led is not set (invalid input)
<b>SETSOURCE</b>	Set source as enable/ disable.	string n, integer b (n = HDMI1, n = HDMI2, n = HDMI3, n = HDMI4, n = DP, n = OPS, n = TYPE-C, n = WIDI ) (b = 1(enable), b = 0(disable))	##*Selected source n ##*Enable/Disable state :b
<b>GETSOURCE</b>	Gets source.	Gets source.	##*source is ...
<b>SETSOURCENAME</b>	Changes source name with given index.	string n - integer m n = New source name m = Source index (HDMI1 = 5, HDMI2 = 8, HDMI3 = 9, HDMI4 = 10, DP = 6, OPS = 7, TYPE-C = 11, WIDI = 15) (Example=SETSOURCE NAME ASLI 5)	##* <old source name> source name changed with <new source name> or ##*Source not available
<b>GETSOURCENAME</b>	Gets the source name with given index.	integer n n = Source index (HDMI1 = 5, HDMI2 = 8, HDMI3 = 9, HDMI4 = 10, DP = 6, OPS = 7, TYPE-C = 11, WIDI = 15)	##*Source name is ... or ##*Source not available
<b>KEY</b>	Send key.	string-integer n (n = 0, n = 1, ....., n = up, ....., n = menu, .....ext.)	n key sent
<b>GETSWVERSION</b>	Returns the software version of panel.	no parameter	##*V...
<b>GETMODELNO</b>	Get model no.	no parameter	*Model no: ...
<b>SETMODELNO</b>	Set model no.	string-integer n	##*ACK or ##*NACK
<b>GETSERIALNO</b>	Get serial no. (returns ##*NACK if no serial number has been set)	no parameter	##*<Serial no> or ##*NACK
<b>SETSERIALNO</b>	Set serial no.	string-integer n	##*ACK or ##*NACK

SETFTIPIN	Set FTI PIN number	integer n (n is a four digit number)	#*FTI PIN was set to n
GETFTIPIN	Get FTI PIN number	no parameter	#*The FTI PIN is n
<b>CHANGELNG</b>	Change active language	integer n n = language( 0="Turkish", 1="English",2="Albanian", 3="Arabic",4="Azerbaijani", 5="Belarusian",6= "Bosnian",7="Bulgarian", 8="Czech",9="Danish", 10="Dutch",11="Estonian", 12="Finnish",13="French", 14="German",15="Gaelic", 16="Greek",17="Hebrew", 18="Croatian",19= "Hungarian",20="Italian", 21="Kazakh",22="Latvian", 23="Lithuanian", 24="Macedonian", 25="Norwegian", 26="Persian",27="Polish", 28="Portuguese", 29="Romanian"," 30="Russian", 31="Slovak",32= "Slovenian",33="Spanish", 34="Serbian",35="Swedish", 36="Thai",37="Ukranian", 38="Vietnamese" 39=","Japanese")  Example: CHANGELNG 0 (To set system language to Turkish)	#* [old language] language changed to n or #* Incorrect item parameter entered

<b>SETCOUNTRY</b>	Set country	string n Valid country strings are below: TURKEY, UK, ALBANIAN, AUSTRALIA, AUSTRIA, BELARUSIAN, BELGIUM, BULGARIA, COLOMBIA, CROATIA, CYPRUS, CZECH, DENMARK, ESTONIA, FINLAND, FRANCE, GERMANY, GREECE, HUNGARY, INDIA, IRAQ, IRELAND, ISRAEL, ITALY, JORDAN, LATVIA, LEBANON, LITHUANIA, LUXEMBOURG, MACEDONIA, MALTA, NETHERLANDS, NEW ZEALAND, NORWAY, IRAN, POLAND, PORTUGAL, ROMANIA, RUSSIA, SAUDI ARABIA, SERBIA, SLOVAKIA, SLOVENIA, SPAIN, SWEDEN, SWITZERLAND, THAILAND, UKRAINE, VIETNAM, JAPAN	#* setCountry() set to n or #*Incorrect item parameter entered
<b>GETCOUNTRY</b>	Get country	no parameter	#*COUNTRY IS : ...
<b>SETCUSTOMERNAME</b>	Change Customer name	string n ( n = Customer name)	#*Customer name is set as n
<b>GETCUSTOMER</b>	Get Customer name	no parameter	#*Customer: [CUSTOMER]#*
<b>BUILDINFO</b>	Reports the build info.	no parameter	#*Build info = ... #*Build Date = ...
<b>FACTORY</b>	Load factory settings to NVRAM. Settings are updated with defaults.	no parameter	#*Factory Settings were loaded to NVRAM.
<b>RESET</b>	Reset the device.	no parameter	#*Reset hardware
<b>MENUTIMEOUT</b>	Set menu time out mode.	integer n ( n = 0 , n = 15, n = 30, n = 45, n = 60)	#*set menu timeout mode to OFF or #*set menu timeout mode to 60 or #*Invalid menu timeout mode

<b>GETMENUTIMEOUT</b>	Get menu time out mode	no parameter	#*menu timeout mode is OFF or #*menu timeout mode is n or #*can not get menu timeout mode Note: Above n is one of (15, 30,45, 60)
<b>AUTOTVOFF</b>	Set auto panel off level.	integer n (0 = off, 1 = 1 HOUR, 2 = 2 HOUR, 3 = 3 HOUR, 4 = 4 HOUR, 5 = 5 HOUR, 6 = 6 HOUR, 7 = 7 HOUR, 8 = 8 HOUR )	#*set auto display off mode to n or #*set auto display off mode to OFF or #*auto display off must be Integer and between [0-8]
<b>GETAUTOTVOFF</b>	Get auto panel off mode.	no parameter	#*auto Display off is n or #*auto Display off is OFF
<b>GETSTANDBY</b>	Get standby on/off.	no parameter	#*standby off or #*standby on
<b>INTERACTIVE STANDBY</b>	Enter active standby state	no parameter	#*Display will be sent to Active Standby state! or #*Display is in Active Standby state already!
<b>EXITACTIVESTANDBY</b>	Exit active standby state	no parameter	#Display will be turned on! or #* Display is not in Active Standby state!
<b>GETTVLIFETIME</b>	Prints panel life time in minutes.	no parameter	#*Display Life Time: n
<b>SETPOWERONDELAY</b>	Set poweron delay level	integer n (0<=n<=20, delay is calculated as 100ms*n)	#*Power on delay set to ... ms or #*NACK
<b>GETPOWERONDELAY</b>	Get poweron delay level	no parameter	#*The power on delay is ... ms
<b>SIGNAGERESET</b>	Set all items in the signage settings menu to their default values.	no parameter	#*All signage settings set to default values
<b>SWOL</b>	Set Wake on Lan option	integer n ( n = 1 (enable), n = 0 (disable))	#*Wake on Lan is set to enable. or #*Wake on Lan is set to disable. or #*NACK

<b>GWOL</b>	Get Wake on Lan option	no parameter	#*Wake on Lan is enable. or #*Wake on Lan is disable.
<b>TIME</b>	Display the current date and time.	no parameter	Time = ...
<b>SETTIMEMODE</b>	Set time mode	string n ("auto", "manual")	#*set time mode to n or #*invalid input type
<b>GETTIMEMODE</b>	Get time mode	no parameter	#*time mode is n Note: Above n is "auto" or "manual".
<b>SETPOWERMODE</b>	Set Power Mode (SETPOWERMODE n)	string n (Eco,Reactive)	#*Set power mode to ... or #*Invalid power mode parameter (<Eco/Reactive>)
<b>GETPOWERMODE</b>	Returns Power Mode (Eco or Reactive)	no parameter	#*Power mode is ....
<b>GETCPU TEMPERATURE</b>	Gets cpu temperature	no parameter	#*cpu temperature is ...
<b>GETRAMUSAGE PERCENTAGE</b>	Gets ram usage percentage	no parameter	#*memory usage percentage is ... or #*can not get memory usage percentage
<b>set_video_output</b>	Switch on and off, all the Panel Supply Voltages and Video Signals	integer n (0 = off, 1 = on)	#*Video output is set to 0 or #*Video output is set to 1 or #*Invalid parameter
<b>screen_capture_usb</b>	Capture specified surface as png to USB stick.	integer n (0 for UI, 8 for video layer)	#*Screen capture is successfull. or #*Screen capture failed!
<b>VIDOFF</b>	Hides video.	no parameter	#*Video off.
<b>VIDON</b>	Shows video.	no parameter	#*Video on.
<b>GETVIDSTATE</b>	Get video state.	no parameter	#*Video is on or #*Video is off
<b>SETSCHEDULER</b>	enables/disables scheduler	string n (N_X, N_X) (N is scheduler number (1,2,3,4), X is "ON" or "OFF") ----- "SETSCHEDULER N_X" (SETSCHEDULER 1_OFF) (SETSCHEDULER 2_ON)	#*The scheduler Plan N (1,2,3,4) is set to X (ON, OFF) or #*Wrong parameter entered

<b>GETSCHEDULER</b>	gets scheduler enabled/ disabled	"GETSCHEDULER N" (N is scheduler number) ----- ----- "GETSCHEDULER 1"	#*The scheduler Plan N (1,2,3,4) is ... (ON, OFF) or #*Wrong parameter entered
<b>SETSCHEDULEOP</b>	sets scheduler parameters	string n ( schedulerplannumber_ onenabled_ontime_ offenabled_ offtime_days_ sourceorbrightness_value in format: A_B_hh:mm_C_ hh:mm_D_E_F ) A = 1, 2, 3, 4 B = 0, 1 C = 0, 1 D = XXXXXX (X = 0, 1) E = 0, 1 (0 = source, 1 = brightness) F; if E = 0, Available source names: Last Source USB DP OPS Type C HDMI 1 HDMI 2 HDMI 3 HDMI 4 if E = 1, backlight value = 0, 5, 10, 15, 20, 25, 30, 35, 40, 45, 50, 55, 60, 65, 70, 75, 80, 85, 90, 95, 100 ----- ----- "SETSCHEDULEOP number_ enabled_ontime_offenabled_ offtime_days_source" (SETSCHEDULEOP 4_1_ 08:00_1_22:00_0111110_0 _HDMI 1)	#*Schedule parameters are ... (set/not set).

<b>GETSCHEDULEOP</b>	gets scheduler parameters	<p>"GETSCHEDULEOP N" (N is scheduler number) N=1, 2, 3, 4 ----- GETSCHEDULEOP 1"</p>	<p>#*Scheduler Plan N (1,2,3,4) on/off time, source and days are: ..... (hh:mm_hh:mm_source_days) or #*Scheduler Plan N (1,2,3,4) on/off time, backlight and days are: ..... (hh:mm_hh:mm_backlight_days) or #*Scheduler Plan N (1,2,3,4) is not set or #*Wrong parameter entered</p>
<b>STARTFTI</b>	start first time installation	no parameter	

#### MODE COMMANDS

Command	Description	Parameter	Return
<b>SETSTARTUPSOURCE</b>	Sets startup source which has been entered after power off on	integer n ( $1 \leq n \leq 7$ ) Source Index (n=1) DP (n=2) SLOT/OPS (n=3) TYPE C (n=4) HDMI1 (n=5) HDMI2 (n=6) HDMI3 (n=7) HDMI4	#* The startup source is set to ... or #* Invalid startup source is entered.
<b>GETSTARTUPSOURCE</b>	Gets startup source which has been entered after power off on	no parameter	#*The startup source is ...
<b>SETSTARTUPMODE</b>	Set start up mode	integer n ( $0 \leq n \leq 2$ ) (n = 0 => On, n = 1 => Standby, n = 2 => Last)	#*The startup mode is ... or #*Invalid startup mode entered.
<b>GETSTARTUPMODE</b>	Get startup mode	no parameter	#*The startup mode is ...
<b>SETPANELLOCK</b>	Set Panel lock availability (ON,OFF)	string n (ON, OFF)	#*Set panel lock to ... or #*Invalid panel lock parameter
<b>GETPANELLOCK</b>	Get panel lock availability	no parameter	#*The panel lock is ... or #*Panel lock has not been set yet.
<b>SETMAXVOLUME</b>	Set volume maximum level	integer n ( $0 \leq n \leq 100$ )	#* Maximum volume limit is set to ... or #* Invalid volume parameter!
<b>GETMAXVOLUME</b>	Get volume maximum level	no parameter	#*Maximum volume limit is ...
<b>GETMINVOLUME</b>	Get volume minimum level	no parameter	#The minimum volume is ...

<b>SETSTARTVOLUME</b>	Set startup volume	integer n (0 ≤ n ≤ 100)	#*Start up volume is set to ... or #*Volume can not be higher than maximum volume #*Invalid volume parameter!
<b>GETSTARTVOLUME</b>	Get startup volume	no parameter	#*Start up volume is ...

#### MEDIA BROWSER COMMANDS

Command	Description	Parameter	Return
<b>SETSLIDESHOW INTERVAL</b>	set slide show interval	integer n ( 5, 10, 15, 20, 25, 30 )	#*The slideshow interval is set to ... seconds
<b>GETSLIDESHOW INTERVAL</b>	get slide show interval	no parameter	#*The slideshow interval is ... seconds
<b>SETUSBAUTOPLAY</b>	set usb autoplay mode	string n (ON, OFF)	#*The USB autoplay is set to ... (ON, OFF)
<b>GETUSBAUTOPLAY</b>	get usb autoplay mode	no parameter	#*The USB autoplay is ... (1, 0)
<b>SETMBSUBTPOS</b>	set subtitle position	string n (Up, Down)	#*The subtitle position is set to ... (up, down)
<b>GETMBSUBTPOS</b>	get subtitle position	no parameter	#*The subtitle position is ... (up, down)
<b>SETMBSUBTFONTSIZE</b>	set subtitle font size	integer n	#*The media browser subtitle font size is set to ...
<b>GETMBSUBTFONTSIZE</b>	get subtitle font size	no parameter	#*The media browser subtitle font size is ... ( font size as in setter's parameters section)

#### SIGNAGE SETTINGS COMMANDS

Command	Description	Parameter	Return
<b>GETTOTALSPACE</b>	get total usb space	no parameter	#*The total space is ...
<b>GETFREESPACE</b>	get free usb space	no parameter	#*The free space is ...
<b>OPENDISPLAY SETTINGS</b>	Opens the Display Settings dialog	no parameter	#*Display Settings is opened
<b>SETMODE_EMBEDDED TOUCH</b>	Set the embedded touch mode	string (External,OPS,Display, TypeC,Auto)	#*Embedded touch mode is set to ***** or #*Embedded touch mode is not set (invalid input)
<b>SETMODE_WIFIBT</b>	Set the wifi&bt switch value	string wifibt string usb string (Display,OPS,Auto)	#*Wifi & BT Switch Mode is set to ***** or #*Wifi & BT Switch Mode is not set (invalid input)



<b>SETMODE_USB</b>	Set the Front&Internal USB status value	string usb string wifibt string (Display,OPS,Auto)	#*USB Mode is set to ***** or #*USB Mode is not set (invalid input)
<b>SETSIGNAGEID</b>	Set Signage ID	integer n	#*Set Signage ID Success. or #*Wrong parameter. Parameters must be integer
<b>GETSIGNAGEID</b>	Get Signage ID	no parameter	#*The signage ID is ... or #*The signage ID is 0 #*Do not forget to enter signage ID! (If return value is 0)
<b>SHOWSIGNAGEID</b>	display signage ID on screen	no parameter	#* Signage ID is ... or #* Signage ID is 0 #*Do not forget to enter signage ID! (If return value is 0)

#### NETWORK COMMANDS

Command	Description	Parameter	Return
<b>get_IP_address</b>	Get IP address of eth0 network interface. Usage: get_IP_address	no parameter	#*IPAddr: ...
<b>SAVEWIFIPROFILE</b>	Save access point to wifi_profile.	str-int ssid, bssid key	Profile saved. or Number of profiles exceeds the maximum number to be stored.
<b>Wifi</b>	checks if given SSID wifi is found or not and returns Pass or Fail.	str-int ssid	#*Pass or #*FAIL
<b>GETNETWORKTYPE</b>	get network type (eg. GETNETWORKTYPE)	no parameter	#*the network type is <network-type>
<b>SETSUBNETMASK</b>	set subnet mask (subnet mask value should be of format nnn.nnn.nnn.nnn) (eg. SETSUBNETMASK nnn.nnn.nnn.nnn)	string "nnn.nnn.nnn.nnn"	#*set subnet mask: nnn.nnn.nnn.nnn or #*setting subnet mask is failed
<b>GETSUBNETMASK</b>	get subnet mask (eg. GETSUBNETMASK)	no parameter	#*the subnet mask is nnn.nnn.nnn
<b>SETDEFAULTGATEWAY</b>	set default gateway (default gateway value should be of format nnn.nnn.nnn.nnn) (eg. SETDEFAULTGATEWAY nnn.nnn.nnn.nnn)	string "nnn.nnn.nnn.nnn"	#*set default gateway: nnn.nnn.nnn.nnn or #*setting default gateway is failed
<b>GETDEFAULTGATEWAY</b>	get default gateway (eg. GETDEFAULTGATEWAY)	no parameter	#*the default gateway is nnn.nnn.nnn.nnn

<b>SETDNS1</b>	set DNS server 1 (DNS server value should be of format nnn.nnn.nnn.nnn) (eg. SETDNS1 nnn.nnn.nnn.nnn)	string "nnn.nnn.nnn.nnn"	##*set DNS server 1 to: nnn.nnn.nnn.nnn or ##*setting DNS server 1 failed
<b>GETDNS1</b>	get DNS server 1 (eg. GETDNS1)	no parameter	##*DNS server 1 is nnn.nnn.nnn.nnn
<b>SETDNS2</b>	set DNS server 2 (DNS server value should be of format nnn.nnn.nnn.nnn) (eg. SETDNS2 nnn.nnn.nnn.nnn)	string "nnn.nnn.nnn.nnn"	##*set DNS server 2 to: nnn.nnn.nnn.nnn or ##*setting DNS server 2 failed
<b>GETDNS2</b>	get DNS server 2 (eg. GETDNS2)	no parameter	##*DNS server 2 is nnn.nnn.nnn.nnn
<b>GETINTERNETSPEED</b>	get internet speed	no parameter	##*The internet speed is ... Mbps
<b>SETPROXY</b>	Sets proxy configuration	string (nnn.nnn.nnn.nnn:nnnn)	##*addr = nnn.nnn.nnn.nnn, port = nnnn
<b>GETPROXY</b>	Gets proxy configuration	no parameter	##*Current proxy is nnn.nnn.nnn.nnn:nnnn or ##*No proxy address
<b>CLEARPROXY</b>	Clears proxy configuration	no parameter	##*Proxy was cleaned

#### PC COMMANDS

Command	Description	Parameter	Return
<b>SETOSDORIENTATION</b>	Set OSD orientation	string-integer n ( n = landscape, n = portrait, n = portrait2) ( landscape : 0 degree rotation, portrait : 90 degree rotation, portrat2: 270 degree rotation)	##*Wrong parameter entered (landscape, portrait, portrait2) or ##*The OSD orientation set OK or ##*The OSD orientation set NOK
<b>GETOSDORIENTATION</b>	Get OSD orientation	no parameter	##*The OSD orientation ...
<b>SETOPSPower</b>	Set OPS power status	string parameter "on" or "off"	##*Turning OPS on ##*Turning OPS off ##*The OPS is already on ##*The OPS is already off ##*The OPS is not enabled ##*The OPS is not plugged in ##*invalid value entered
<b>GETOPSPower</b>	Get OPS power status	no parameter	##*The OPS is on ##*The OPS is off ##*The OPS is not enabled ##*The OPS is not plugged in

<b>SETOPSALWAYSON</b>	Set OPS Always on value	string parameter "true" or "false"	#*invalid value entered #*The OPS is not enabled #*OPS Always on set as true #*OPS Always on set as false
-----------------------	-------------------------	------------------------------------	--

### PICTURE COMMANDS

Command	Description	Parameter	Return
<b>SETBACKLIGHT</b>	Set backlight pin status.	str-int n (n = ON, n = OFF)	#*setBacklight port to ON or #*setBacklight port to OFF
<b>SETBACKLIGHTLEVEL</b>	Set backlight level.	int n ( $0 \leq n \leq 100$ )	#*Backlight level set to n or #*NACK
<b>GETBACKLIGHTLEVEL</b>	Get backlight level.	no parameter	#*The backlight level is ...
<b>COLOURTEMP</b>	Set colour temperature.	str-int n (n = normal, warm, cool)	#*setColourTemp() set to n
<b>GETCOLOURTEMP</b>	Get colour temperature.	no parameter	#*Colour temp is ...
<b>PICTUREMODE</b>	Select picture mode.	Display ----> int n (1 = dynamic, 2 = natural, 3 = cinema, 4 = game, 5 = sport) Signage ----> int n (1 = signage, 2 = natural, 3 = text, 4 = game, 5 = sport)	#*setPictureMode() set to n or #*Incorrect picture mode parameter entered
<b>GETPICTUREMODE</b>	Get picture mode.	no parameter	#*Picture Mode is ... for current source
<b>GETCONTRAST</b>	Get picture contrast value.	no parameter	#*THE CONTRAST VALUE : ...

<b>SETCONTRAST</b>	Set picture contrast value.	int n ( $0 \leq n \leq 100$ )	#*Picture contrast value is set to n or #*Same value is set. Do nothing. or #*Incorrect parameter entered! Value must be in the range 0-100
<b>GETBRIGHTNESS</b>	Get picture brightness value.	no parameter	#*THE BRIGHTNESS VALUE : ...
<b>SETBRIGHTNESS</b>	Set picture brightness value.	int n ( $0 \leq n \leq 100$ )	#*Picture brightness value is set to n or #*Same value is set. Do nothing. or #*Incorrect parameter entered! Value must be in the range 0-100

<b>GETSHARPNESS</b>	Get picture sharpness value.	no parameter	#*THE SHARPNESS VALUE : ...
<b>SETSHARPNESS</b>	Set picture sharpness value.	int n (0 ≤ n ≤ 100)	#*Picture brightness value is set to n or #*Same value is set. Do nothing. or #*Incorrect parameter entered! Value must be in the range 0-100
<b>PICTUREZOOM</b>	Set picture zoom mode.	str-int n (n = auto, 16:9, subtitle, 14:9, 14:9zoom, 4:3, full(only for HD channels), cinema) Customer Christie => ( n = auto shows Overscan on Display )	#*setPictureZoomMode() set to n or #*Incorrect picture zoom mode parameter entered
<b>GETPICTUREZOOM</b>	Get picture zoom mode.	no parameter	#*Picture zoommode is ...
<b>SETNOISEREDUCTION</b>	Set noise reduction.	str-int n (n = OFF, n = LOW, n = MEDIUM, n = HIGH)	#*NoiseReduction set to n or #*Missing noise reduction state
<b>GETNOISEREDUCTION</b>	Get noise reduction.	no parameter	#*NoiseReduction is ...
<b>BRIGHTNESSUP</b>	Increase Brightness Level by 1 step	no parameter	Picture brightness value is set to ... or Picture brightness value is at max value. You can not increase brightness level further.
<b>BRIGHTNESSDOWN</b>	Decrease Brightness Level by 1 step	no parameter	Picture brightness value is set to ... or Picture brightness value is at min value. You can not decrease brightness level further.
<b>CONTRASTUP</b>	Increase Contrast Level by 1 step	no parameter	Picture contrast value is set to ... or Picture contrast value is at max value. You can not increase contrast level further.
<b>CONTRASTDOWN</b>	Decrease Contrast Level by 1 step	no parameter	Picture contrast value is set to ... or Picture contrast value is at min value. You can not decrease contrast level further.

<b>SETMICRODIMMING</b>	Set micro dimming	str-int n (n = OFF, n = LOW, n = MEDIUM, n = HIGH)	#* Set Micro Dimming Level n or #*Invalid parameter. Set Micro Dimming Level (OFF, LOW, MEDIUM, HIGH)
<b>GETMICRODIMMING</b>	Get micro dimming	no parameter	#*Micro Dimming Level ...
<b>SETCOLOURSHIFT</b>	Set colour shift.	int n (-50 <= n <= 50)	#*Colour shift is set to n or #* Same value is set. Do nothing. #*Incorrect parameter entered ! Value must be between defined ranges
<b>GETCOLOURSHIFT</b>	Get colour shift.	no parameter	#*Colour shift is ...
<b>SETWB</b>	Set white balance value.	str-int type, value (type = redgain, greengain, bluegain, redoffset, greenoffset, blueoffset) (0 ≤ value ≤250)	#*White Balance is set to value or Invalid value for White Balance (0-255) or Invalid type for White Balance
<b>INCWB</b>	Increment white balance value by n.	str-int type n (type = redgain, greengain, bluegain, redoffset, greenoffset, blueoffset) (0 ≤ n ≤250)	#*White Balance is set to ... or Invalid value for White Balance (0-255) or Invalid type for White Balance
<b>DECWB</b>	Decrement white balance value by n.	str-int type n (type = redgain, greengain, bluegain, redoffset, greenoffset, blueoffset) (0 ≤ n ≤250)	#*White Balance is set to ... or Invalid value for White Balance (0-255) or Invalid type for White Balance
<b>GETWB</b>	Get white balance value.	str-int type (type = redgain, greengain, bluegain, redoffset, greenoffset, blueoffset)	#* type ...
<b>HDR</b>	Set HDR Mode	str-int n (n = ON, n = OFF)	HDR mode is n or Invalid parameter...
<b>SETDYNAMIC CONTRAST</b>	Set dynamic contrast.	str-int n (n = OFF, n = LOW, n = MEDIUM, n = HIGH)	#*Dynamic contrast value is set to n or #*Invalid parameter. Set Dynamic Contrast value (OFF, LOW, MEDIUM, HIGH)

<b>GETDYNAMIC CONTRAST</b>	Get dynamic contrast.	no parameter	#*Dynamic contrast is ...
<b>SETGAMMAPOWER</b>	Set gamma power	int n (limits not clarified)	Gamma Power Mode is set to n
<b>GETGAMMAPOWER</b>	Get gamma power	no parameter	Gamma Power Mode is ...
<b>SETGAMUTMODE</b>	Set gamut mode	int n (limits not clarified)	Gamut Color Mode is set to n
<b>GETGAMUTMODE</b>	Get gamut mode	no parameter	Gamut Color Mode is ...

#### BROWSER COMMANDS

Command	Description	Parameter	Return
<b>OPENURL</b>	Starts the given URL and returns web page load status directly.	string-integer n <load url='n' />	#*status= ... url=n
<b>GETURL</b>	Gets URL of the current page if the portal is active.	no parameter	#*URL : ...
<b>SETSETTINGSURL</b>	Sets the browser settings URL (URL set by the command is opened with long press on CMS key)	string	#*Setting URL is set
<b>GETSETTINGSURL</b>	Gets the browser settings URL	no parameter	#*Setting URL is ...
<b>SETSTARTURL</b>	Sets the start URL	string	#*Start URL is set
<b>GETSTARTURL</b>	Gets the start URL	no parameter	#*Start URL is ...
<b>GETUSERAGENT</b>	Gets portal user agent.	no parameter	#*Current UA : ...

<b>CLEARCACHE</b>	Clear browser cache/ cookies (Private datas like web form)	no parameter	#*Browser cookies are cleared
<b>CLEARBROWSERDATA</b>	Clear browser data files like History, Bookmarks, Speed Dial and Configuration	no parameter	#*Browser data files are cleared
<b>GETCMSSTATUS</b>	Gets the CMS status	no parameter	#*Do cms status assignment with SETCMSSTATUS command or Returns the value of cms status
<b>SETCMSSTATUS</b>	Sets the CMS status	string parameter max. length of 255 characters	#*CMS status set to ... or #*NACK
<b>GETCMSPARAMS</b>	Gets the CMS parameters	no parameter	#*Do cms param assignment with SETCMSPARAMS command. or Returns the value of cms params

<b>SETCMSPARAMS</b>	Sets the CMS parameters	string parameter max. length of 255 characters	#*CMS params set to ... or #*NACK
<b>SETBROWSERDEBUG</b>	Sets the browser debug 4725 port	string n (n = ON, n = OFF)	browser debug 4725 port is enabled or browser debug 4725 port is disabled
<b>SETBROWSECORS</b>	Set browser cors status to enable disable web security flag	int n (n = 0,1)	#*Browser cors is enabled or #*Browser cors is disabled or #*Browser cors operation is failed *Reboot is required after the command is executed
<b>GETBROWSECORS</b>	Get browser cors status	no parameter	#*Browser cors is enabled or #*Browser cors is disabled

## RS232 HEX Commands

### Protocol Test Steps

- Before testing, please know the board type you have. There are two types of board. The UART 0 and UART 1 connections of these boards are explained below:
  1. RJ12 is connected to UART 0, DSUB9 is connected to UART 1. Therefore, UART 0 and UART 1 could be tested separately in this type of the board
  2. RJ12 and DSUB9 both are connected to UART 0. UART 1 is supported for OPS module but not reachable. Therefore, only UART 0 could be tested in this type of the board.
- Activate HEX protocol on Display.
  - a. Enter **Display Settings > Signage Settings > Controls** menu
  - b. Change the **ASCII** option to **HEX** in **UART0** or **UART1** sub-menu item
- Open any serial port communications program (e.g Realterm). Configure serial communication settings as below:

<b>Baud Rate</b>	: 19200 for UART0, 9600 for UART1
<b>Parity</b>	: None
<b>Data Bits</b>	: 8
<b>Stop Bits</b>	: 1
<b>Handshake</b>	: None
- Note that **UART0** default value: **ASCII**, **UART1** default value: **HEX**  
In the tables given below, XY represents are variable byte.  
All byte values are hexadecimal.

### Error Responses

- **NAK reply: 15** When the display cannot understand the received command, it returns this value. In such a case, check the sending code and send the same command again.
- **Error reply: 1C 00 00** When the display cannot execute the received command for any reasons, it returns this value. In such a case, check the sending code and the setting status of the display.



Command received by display														Reply sent by display for successful operation			Notes		
Byte Number		0	1	2	3	4	5	6	7	8	9	10	11	12	0	1		2	
		Header						Data											
		Header code		Packet	Data Size		CRC flag		Action		Type		Setting code						
Name	Operation	L	H		L	H	L	H	L	H	L	H	L	H					
Monitor	ON	BE	EF	03	06	00	19	D3	02	00	00	60	02	00	06			Power Mode (Quick Standby) should be enabled to be able to turn on the Display with this command.	
	OFF	BE	EF	03	06	00	19	D3	02	00	00	60	01	00	06				
	GET	BE	EF	03	06	00	19	D8	03	00	00	60	07	00	1D	00	XY	XY can be either 00 or 01. 00 means OFF, 01 means ON.	
Mute	ON	BE	EF	03	06	00	D6	D2	01	00	02	20	01	00	06				
	OFF	BE	EF	03	06	00	46	D3	01	00	02	20	00	00	06				
	GET	BE	EF	03	06	00	75	D3	02	00	02	20	00	00	1D	00	XY	XY can be either 00 or 01. 00 means OFF, 01 means ON.	
Screen	ON	BE	EF	03	06	00	68	D9	01	00	20	30	01	00	06				
	OFF	BE	EF	03	06	00	FB	D8	01	00	20	30	00	00	06				
	GET	BE	EF	03	06	00	C8	D8	02	00	20	30	00	00	1D	00	XY	XY can be either 00 or 01. 00 means OFF, 01 means ON.	
Source	OPS	BE	EF	03	06	00	FE	D2	01	00	00	20	00	00	06				
	HDMI	BE	EF	03	06	00	0E	D2	01	00	00	20	03	00	06				
	VGA	BE	EF	03	06	00	6E	D2	01	00	00	20	01	00	06				
	SCART2 (CVBS)	BE	EF	03	06	00	00	00	01	00	00	20	04	00	06				
	FAV	BE	EF	03	06	00	00	00	01	00	00	20	05	00	06				
	S-Video	BE	EF	03	06	00	00	00	01	00	00	20	06	00	06				
Source	HDMI2	BE	EF	03	06	00	00	00	01	00	00	20	08	00	06				
	HDMI3	BE	EF	03	06	00	00	00	01	00	00	20	09	00	06				
	HDMI4	BE	EF	03	06	00	00	00	01	00	00	20	0A	00	06				
	YPbPr	BE	EF	03	06	00	00	00	01	00	00	20	08	00	06				
	SCART2 (S-Video)	BE	EF	03	06	00	00	00	01	00	00	20	0D	00	06				
	TV	BE	EF	03	06	00	00	00	01	00	00	20	0E	00	06				
	SCART1 (CVBS)	BE	EF	03	06	00	00	00	01	00	00	20	0F	00	06				
	SCART1 (S-Video)	BE	EF	03	06	00	00	00	01	00	00	20	10	00	06				
	DVD	BE	EF	03	06	00	00	00	01	00	00	20	11	00	06				
	DVI	BE	EF	03	06	00	00	00	01	00	00	20	12	00	06				
	DP	BE	EF	03	06	00	00	00	01	00	00	20	13	00	06				
	WIDI	BE	EF	03	06	00	00	00	01	00	00	20	15	00	06				
	GET		BE	EF	03	06	00	CD	D2	02	00	00	20	00	00	1D	00	XY	XY can be one of the following: 01: OPS, 02: HDMI, 03: VGA, 04: SCART2(CVBS), 05: FAV, 06: S-Video, 08: HDMI2, 09: HDMI3, 0A: HDMI4, 0B: YPbPr, 0D: SCART2(S-Video), 0E: TV, 0F: SCART1(CVBS), 10: SCART1(S-Video), 11: DVD, 12: DVI, 13: DP, 15: WIDI  Note that all of the sources are not enabled.

Command received by display															Reply sent by display for successful operation			Notes
Byte Number		0	1	2	3	4	5	6	7	8	9	10	11	12	0	1	2	
		Header						Data										
		Header code		Packet	Data Size		CRC flag		Action		Type		Setting code					
Name	Operation	L	H		L	H	L	H	L	H	L	H	L	H				
Volume	GET	BE	EF	03	06	00	31	D3	02	00	01	20	00	00	1D	00	XY	
	INCREMENT	BE	EF	03	06	00	57	D3	04	00	01	20	00	00	06			
	DECREMENT	BE	EF	03	06	00	86	D2	05	00	01	20	00	00	06			
	SET	BE	EF	03	06	00	31	D3	03	00	01	20	01	XY	06			XY can take 00 as a minimum and 1D as a maximum.
OPS Power	ON	BE	EF	03	06	00	BA	D2	01	00	05	20	01	00	06			
	OFF	BE	EF	03	06	00	2A	D3	01	00	05	20	00	00	06			
	GET	BE	EF	03	06	00	19	D3	02	00	05	20	00	00	1D	00	XY	XY can be either 00 or 01. 00 means OFF, 01 means ON.
Bedlight	GET	BE	EF	03	06	00	89	D2	02	00	03	20	00	00	1D	00	XY	
	INCREMENT	BE	EF	03	06	00	EF	D2	04	00	03	20	00	00	06			
	DECREMENT	BE	EF	03	06	00	3E	D3	05	00	03	20	00	00	06			
	SET	BE	EF	03	06	00	89	D2	03	00	03	20	01	XY	06			range: 0x64-0x1E
Auto Adjust	ON	BE	EF	03	06	00	32	D4	01	00	19	20	01	00	06			Auto Adjust command is for only VGA.
	OFF	BE	EF	03	06	00	A2	D5	01	00	19	20	00	00	06			
Keypad Lock	ON	BE	EF	03	06	00	93	97	01	00	11	24	01	00	06			
	OFF	BE	EF	03	06	00	03	96	01	00	11	24	00	00	06			
	GET	BE	EF	03	06	00	30	96	02	00	11	24	00	00	1D	00	XY	XY can be either 00 or 01. 00 means OFF, 01 means ON.
Remote Controller Lock	ON	BE	EF	03	06	00	77	97	01	00	16	24	00	00	06			
	OFF	BE	EF	03	06	00	E7	96	01	00	16	24	01	00	06			
	GET	BE	EF	03	06	00	44	97	02	00	16	24	00	00	1D	00	XY	XY can be either 00 or 01. 00 means OFF, 01 means ON.
OSD Menu	ON	BE	EF	03	06	00	6A	63	01	00	00	37	01	00	06			
	OFF	BE	EF	03	06	00	FA	62	01	00	00	37	00	00	06			
Contrast	GET	BE	EF	03	06	00	FD	D3	02	00	04	20	00	00	1D	00	XY	
	SET	BE	EF	03	06	00	FD	D3	03	00	04	20	01	XY	06			range: 0x4E - 0xB2
	INCREMENT	BE	EF	03	06	00	98	D3	04	00	04	20	00	00	06			
	DECREMENT	BE	EF	03	06	00	4A	D2	05	00	04	20	00	00	06			
Auto Position	EXECUTE	BE	EF	03	06	00	91	D0	06	00	0A	20	00	00	06			
Colour Temperature	INCREMENT	BE	EF	03	06	00	08	F5	10	00	80	30	03	00	06			9300K, 6500K, 13000K
	DECREMENT	BE	EF	03	06	00	CB	F8	01	00	80	30	13	00	06			9300K, 6500K, 13000K
	GET	BE	EF	03	06	00	C8	F5	02	00	80	30	00	00	1D	00	XY	XY takes one of the followings: 00=9300K, 01=6500K, 02=13000K
Clock	INCREMENT	BE	EF	03	06	00	19	D4	03	00	02	21	03	00	06			Clock commands are for VGA Clock. They would work independently of the selected source.
	DECREMENT	BE	EF	03	06	00	19	D5	03	00	02	21	04	00	06			
	GET	BE	EF	03	06	00	19	D7	03	00	02	21	06	00	1D	00	XY	XY would be in the range of 00 and 64
Phase	INCREMENT	BE	EF	03	06	00	2F	83	04	00	03	21	00	00	06			Phase commands are for VGA Phase shift. They would work independently of the selected source.
	DECREMENT	BE	EF	03	06	00	FE	82	05	00	03	21	00	00	06			
	GET	BE	EF	03	06	00	49	83	02	00	03	21	00	00	1D	00	XY	XY would be in the range of 00 and 64
H-Position	INCREMENT	BE	EF	03	06	00	97	82	04	00	01	21	00	00	06			
	DECREMENT	BE	EF	03	06	00	46	83	05	00	01	21	00	00	06			
	GET	BE	EF	03	06	00	F1	82	02	00	01	21	00	00	1D	00	XY	XY would be in the range of 00 and 64. Central position is 32.

Command received by display														Reply sent by display for successful operation			Notes	
Byte Number		0	1	2	3	4	5	6	7	8	9	10	11	12	0	1		2
		Header						Data										
		Header code		Packet Size	CRC flag		Action		Type		Setting code							
Name	Operation	L	H	L	H	L	H	L	H	L	H	L	H					
V-Position	INCREMENT	BE	EF	03	06	00	68	83	04	00	00	21	00	00	06			
	DECREMENT	BE	EF	03	06	00	BA	82	05	00	00	21	00	00	06			
	GET	BE	EF	03	06	00	00	83	02	00	00	21	00	00	ID	00	XY	XY would be in the range of 00 and 64. Central position is 32.
Colour Temp Gain R	INCREMENT	BE	EF	03	06	00	52	F4	04	00	B1	30	00	00	06			
	DECREMENT	BE	EF	03	06	00	83	F5	05	00	B1	30	00	00	06			
	GET	BE	EF	03	06	00	34	F4	02	00	B1	30	00	00	ID	00	XY	
Colour Temp Gain G	INCREMENT	BE	EF	03	06	00	16	F4	04	00	B2	30	00	00	06			
	DECREMENT	BE	EF	03	06	00	C7	F5	05	00	B2	30	00	00	06			
	GET	BE	EF	03	06	00	70	F4	02	00	B2	30	00	00	ID	00	XY	
Colour Temp Gain B	INCREMENT	BE	EF	03	06	00	EA	F5	04	00	B3	30	00	00	06			
	DECREMENT	BE	EF	03	06	00	38	F4	05	00	B3	30	00	00	06			
	GET	BE	EF	03	06	00	8C	F5	02	00	B3	30	00	00	ID	00	XY	
Freeze	EXECUTE	BE	EF	03	06	00	00	00	06	00	C0	30	00	00	06			Toggles video freeze status.

## Maximum Pixel Rates

Please note that connection ports and other features shown here may vary depending on the Display model.  
For Ultra HD panels,

Source	Max. Resolution	Colour Space	Bits/Component	Pixel/Rate
HDMI	4K@60Hz	YCbCr4:4:4/RGB	8 bit	594MHz

## Input Matrix

Please note that connection ports and other features shown here may vary depending on the Display model.

Timing		fH (kHz)	fV (Hz)	Dot clock (MHz)	Input		
					HDMI	Type-C	DP
VESA	720 x 400	31.5	70.156	26.25	○	○	○
	640 x 480	31.469	59.95	25.175	○	○	○
	800 x 600	37.879	60.317	40	○	○	○
	1024 x 768	48.363	60.004	65	○	○	○
	1360 x 768	47.712	60.015	85.5	○	○	○
	1920 x 1080	67.5	60	148.5	○	○	○
ED	853x480p	31.5	60	27.03	○	○	○
	1024x576p	31.25	50	27	○	○	○
HD	1280x720p	37.5	50	74.25	○	○	○
		44.995	59.94	74.176	○	○	○
		45	60	74.25	○	○	○
	1920x1080i	28.13	50	74.25	○	○	○
		33.716	59.94	74.175	○	○	○
		33.75	60	74.25	○	○	○
	1920x1080p	56.25	50	148.5	○	○	○
		67.432	59.95	148.35	○	○	○
		67.5	60	148.5	○	○	○
	UHD (Only for 4K models)	3840x2160p	67.5	30	297	○	○
3840x2160p		135	60	594	○	○	○

## Supported Media Formats from USB

### Video Decoder

Codec	Verified Max. Performance	Audio Codec	Container
MPEG-1	1920x1080P @ 60fps	AC3	DAT, MPEG, MPG, TS
MPEG-2	1920x1080P @ 60fps	MP3, PCM	MPEG, MPG, M2V, TS, TP, VOB
MPEG-4 ASP	1920x1080P @ 60fps	MP3, AC-3, AAC, PCM, ADPCM	AVI, MP4, 3GP
MJPEG	1920x1080p @ 30fps	MP3, U-LAW	AVI

Codec	Verified Max. Performance	Audio Codec	Container
XviD	1920x1080p @ 30fps	AC3, MP3	AVI, OGM
H.263	720x576p @ 30fps	MP3, AC-3, AAC, AMR-NB	3GP, 3G2, MP4
H.264	3840x2160 @ 30fps 100Mbps	AAC, AAC-LC, MP3, AC3, PCM, Vorbis, AMR-NB	AVI, MP4, MKV, TS, M2TS, MTS, M4V, FLV, F4V, PMP
H.265 Main 10	7680x4320 @ 24fps 80Mbps, 3840x2160 @ 60fps 80Mbps	AAC, AC3	TS, MP4, MKV
VC-1	1920x1080p @ 25fps	AC3, PCM, DTS	M2TS, MPEG
WMV3	1280x720p @ 30fps	AC3	ASF, MKV
AVS-P16	1920x1080p @ 30fps	-	TS
AVS-P2 Jizhun	720x576p @ 30fps	-	TS
AVS2	3840x2160p @ 60fps	-	TS
VP9 Profile-2	7680x4320 @ 24fps VP9 67Mbps, 4096x2304p @ 60fps VP9 Profile-2 60Mbps	Vorbis	.webm/.vp9/.ivf
VP8	1920x1080p @ 30fps	Vorbis	.webm/.mkv
AV1	3840x2160p @ 60fps 14.6Mbps	AAC, PCM, AC3	MP4, TS

## Video Encoder

Codec	Verified Max. Performance	Audio Codec	Container
H.264	1920x1080p @ 30fps	AAC	-

## Image Decoder

Codec	Resolution	Container
JPEG baseline/Progress	No restriction	JPG, JPEG
BMP	No restriction	BMP
GIF	No restriction	JPG, JPEG

Codec	Resolution	Container
PNG	No restriction	PNG

## Image Encoder

Software image encoder supported.

## Audio Decoder

Codec	Channel	Bit Rate	Sample rate	Container
MPEG 1/2/2.5, Audio Layer 3	2	8 ~ 320 kbps, CBR and VBR	8 ~ 48 kHz	MP2/MP3
PCM, IMA-ADPCM, MS-ADPCM, U-Law	5,1	Up to 1.5Mbps	8 ~ 48 kHz	WAV
Vorbis	5,1	-	8 ~ 96 kHz	OGG
Flac	5,1	VBR	8 ~ 96 kHz	FLAC
APE	2	VBR	8 ~ 48 kHz	Ape
AAC-LC, AAC-HE(AAC+)	5,1	VBR	8 ~ 96 kHz	AAC/M4A
PCM/A-LAW	5,1	-	8 ~ 48 kHz	AIF/AIFF/ALAW
ALAC	2	VBR	8 ~ 48 kHz	alac
WMA Version 7, 8, 9	5,1	8 ~ 320 kbps, CBR and VBR	8 ~ 96 kHz	WMA

## Audio Encoder

Software audio encoder supported.

## Movie Subtitle

Format	Container
SAMI	SMI
Advanced Substation Alpha	ASS / SSA
SubRip	SRT
DVD	SUB
Blue Ray	PGS
Timed text	SBTL
Aqtitle	AQT
Lyric	LRC
MircoDVD	SUB
Mplayer1/2	MPL
Mpsub	SUB

Format	Container
Phoenix Japanimation Society	PJS
subviewer1.0/2.0	SUB
Text	TXT

<b>Format</b>	<b>Container</b>
Vplayer	TXT
Extensible Markup Language	XML
DVB-SUB	DVB
Jacosub	JS

## System Features

### Panel

Panel type	86" (218cm) 24/7 DLED	
Resolution	3840x2160 (16:9) -UHD	
Visual angle	Horizontal	89°
	Perpendicular	89°
Max. brightness	Typ: 400 cd/m2	
H-Frequency	60 KHz	
V-Frequency	67,5 KHz	

### Audio

2 x 15 W Audio Output Power

### Network Connection

1 x Ethernet (LAN) for Internet connectivity

802.11 a/b/g/n/ac built in WLAN support

### Input/Output Ports

1 x RS232 port (3,5 mm)

1 x Ethernet port

1 x USB 3.0 port (5VDC max900mA)

1 x USB 2.0 port (5VDC max500mA)

2 x HDMI 2.0 In port (1.4 for FHD panels)

1 x IR port

1 x Headphone/Line Out port (optional)

1 x HDMI Out port

1 x RJ12 port (for service use only)

### Power

110-240V AC 50-60Hz 400W

### Weight (kg)

45

### Display Dimensions DxLxH (mm)

1928 mm x 1099 mm x 80 mm

### Wireless LAN Transmitter Specifications

Frequency Ranges	Max Output Power
2400 - 2483,5 MHz (CH1 - CH13)	< 100 mW
5150 - 5250 MHz (CH36 - CH48)	< 200 mW (*)
5250 - 5350 MHz (CH52 - CH64)	< 200 mW (*)
5470 - 5725 MHz (CH100 - CH140)	< 200 mW (*)

(\*) '< 100 mW' for the Ukraine

### Country Restrictions

The Wireless LAN equipment is intended for home and office use in all EU countries, the UK and Northern Ireland (and other countries following the relevant EU and/or UK directive). The 5.15 - 5.35 GHz band is restricted to indoor operations only in the EU countries, in the UK and Northern Ireland (and other countries following the relevant EU and/or UK directive). Public use is subject to general authorisation by the respective service provider.

Country	Restriction
Russian Federation	Indoor use only

The requirements for any country may change at any time. It's recommended that user checks with local authorities for the current status of their national regulations for both 2.4 GHz and 5 GHz wireless LAN's.

### Warning

Surges could cause data loss except monitoring modes.

**Note:** Some of the system features including software functions and available ports are optional and dependent on the model options that you have requested.

This document contains all available options for informing purposes.

## Federal Communication Commission Interference Statement

This equipment has been tested and found to comply with the limits for a Class B digital device, pursuant to Part 15 of the FCC Rules. These limits are designed to provide reasonable protection against harmful interference in a residential installation. This equipment generates, uses and can radiate radio frequency energy and, if not installed and used in accordance with the instructions, may cause harmful interference to radio communications. However, there is no guarantee that interference will not occur in a particular installation. If this equipment does cause harmful interference to radio or television reception, which can be determined by turning the equipment off and on, the user is encouraged to try to correct the interference by one of the following measures:

- Reorient or relocate the receiving antenna.
- Increase the separation between the equipment and receiver.
- Connect the equipment into an outlet on a circuit different from that to which the receiver is connected.
- Consult the dealer or an experienced radio/TV technician for help.

**FCC Caution:** Any changes or modifications not expressly approved by the party responsible for compliance could void the user's authority to operate this equipment.



This device complies with Part 15 of the FCC Rules. Operation is subject to the following two conditions: (1) This device may not cause harmful interference, and (2) this device must accept any interference received, including interference that may cause undesired operation.

For product available in the USA/Canada market, only channel 1-11 can be operated. Selection of other channels is not possible.

## IMPORTANT NOTE

### FCC Radiation Exposure Statement

This equipment complies with FCC radiation exposure limits set forth for an uncontrolled environment. This equipment should be installed and operated with minimum distance 20cm between the radiator & your body.

## Accessories Included

- Remote Control
- Batteries: 2 x AAA
- Instruction Book
- Quick Start Guide
- Wall Mount Kit

## Information for Users on Disposal of Old Equipment and Batteries

### [European Union only]

Equipment bearing these symbols should not be disposed as general household waste.

You should look for appropriate recycling facilities and systems for the disposal of these products.

**Note:** The sign Pb below the symbol for batteries indicates that this battery contains lead.

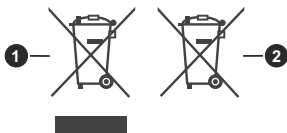

- ① Products
- ② Battery

## Licence Notification

The terms HDMI, HDMI High-Definition Multimedia Interface, HDMI trade dress and the HDMI Logos are trademarks or registered trademarks of HDMI Licensing Administrator, Inc.



Manufactured under licence from Dolby Laboratories. Dolby, Dolby Audio, and the double-D symbol are trademarks of Dolby Laboratories Licensing Corporation.



The Bluetooth® word mark and logos are registered trademarks owned by the Bluetooth SIG, Inc. and any use of such marks by Vestel Elektronik Sanayi ve Ticaret A.S. is under license. Other trademarks and trade names are those of their respective owners.

This product is protected by certain intellectual property rights of Microsoft Corporation. Use or distribution of such technology outside of this product is prohibited without a licence from Microsoft or an authorised Microsoft subsidiary.

## Vesa Wall Mount Measurements

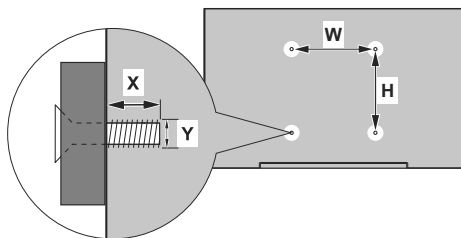

<b>Hole Pattern Sizes (mm)</b>	<b>W</b>	<b>H</b>
	<b>600</b>	<b>400</b>
<b>Screw Sizes</b>		
<b>Length (X)</b>	min. (mm)	<b>11</b>
	max. (mm)	<b>12</b>
<b>Thread (Y)</b>	<b>M8</b>	

## Installation On An Indented Wall

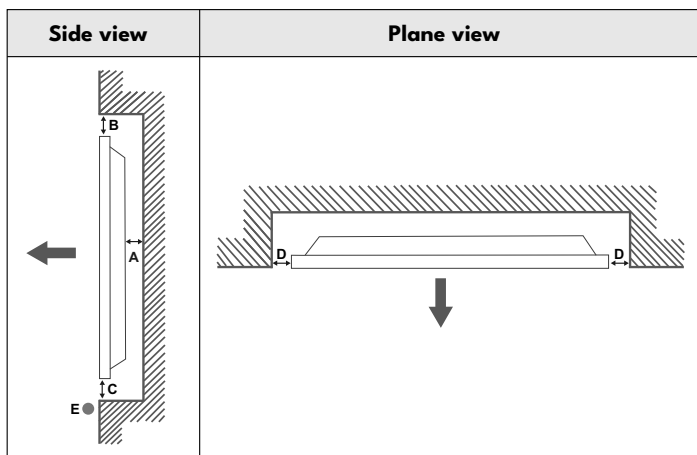

- A** Minimum 50 mm
- B** Minimum 70 mm
- C** Minimum 50 mm
- D** Minimum 50 mm
- E** Ambient temperature range: 0-35°C



When installing the product on an indented wall, allow at least the space specified above between the product and wall for ventilation and ensure that the ambient temperature is kept between 0°C-35°C. Do not expose the product to direct sunlight.

We will take no responsibility for any damages or failures in case our products are not being used subject to these recommendations and/or instructions for use.

- TR: İşbu belgede; VESTEL Elektronik Sanayi ve Ticaret A.Ş., telsiz ekipmanı tipi MONITOR'nin 2014/53/AB sayılı direktife uygun olduğunu beyan eder. AB uyumluk beyanının tam metni internet adresinde mevcuttur: doc.vosshub.com
- EN: Hereby, VESTEL Elektronik Sanayi ve Ticaret A.Ş., declares that the radio equipment type MONITOR is in compliance with Directive 2014/53/EU. The full text of the EU declaration of conformity is available at the following internet address: doc.vosshub.com
- BG: С настоящото VESTEL Elektronik Sanayi ve Ticaret A.Ş., декларира, че този тип радиосъоръжение MONITOR е в съответствие с Директива 2014/53/ЕС. Цялостният текст на ЕС декларацията за съответствие може да се намери на следния интернет адрес: doc.vosshub.com
- CS: Tímto VESTEL Elektronik Sanayi ve Ticaret A.Ş., prohlašuje, že typ rádiového zařízení MONITOR je v souladu se směrnicí 2014/53/EU. Úplné znění EU prohlášení o shodě je k dispozici na této internetové adrese: doc.vosshub.com
- DA: Hermed erklærer VESTEL Elektronik Sanayi ve Ticaret A.Ş., at radioudstyrstypen MONITOR er i overensstemmelse med direktiv 2014/53/EU. EU-overensstemmelseserklæringens fulde tekst kan findes på følgende internetadresse: doc.vosshub.com
- DE: Hiermit erklart VESTEL Elektronik Sanayi ve Ticaret A.Ş., dass der Funkanlagentyp MONITOR der Richtlinie 2014/53/EU entspricht. Der vollständige Text der EU-Konformitätserklärung ist unter der folgenden Internetadresse verfügbar: doc.vosshub.com
- EL: Με την παρούσα ο/η VESTEL Elektronik Sanayi ve Ticaret A.Ş., δηλώνει ότι ο ραδιοεξοπλισμός MONITOR πληροί την οδηγία 2014/53/ΕΕ. Το πλήρες κείμενο της δήλωσης συμμόρφωσης ΕΕ διατίθεται στην ακόλουθη ιστοσελίδα στο διαδίκτυο: doc.vosshub.com
- ES: Por la presente, VESTEL Elektronik Sanayi ve Ticaret A.Ş., declara que el tipo de equipo radioeléctrico MONITOR es conforme con la Directiva 2014/53/UE. El texto completo de la declaración UE de conformidad está disponible en la dirección Internet siguiente: doc.vosshub.com
- ET: Käesolevaga deklareerib VESTEL Elektronik Sanayi ve Ticaret A.Ş., et käesolev raadioseadme tüüp MONITOR vastab direktiivi 2014/53/EL nõuetele. Eli vastavusdeklaratsiooni täielik tekst on kättesaadav järgmisel internetiaadressil: doc.vosshub.com
- FI: VESTEL Elektronik Sanayi ve Ticaret A.Ş., vakuuttaa, että radioalaitetyyppi MONITOR on direktiivin 2014/53/EU mukai-nen. EU-vaatimustenmukaisuusvakuutuksen täysimittainen teksti on saatavilla seuraavassa internetosoitteissa: doc.vosshub.com
- FR: Le soussigné, VESTEL Elektronik Sanayi ve Ticaret A.Ş., déclare que l'équipement radioélectrique du type MONITOR est conforme à la directive 2014/53/UE. Le texte complet de la déclaration UE de conformité est disponible à l'adresse internet suivante: doc.vosshub.com
- HR: VESTEL Elektronik Sanayi ve Ticaret A.Ş., ovime izjavljuje da je radijska oprema tipa MONITOR u skladu s Direktivom 2014/53/EU. Cjeloviti tekst EU izjave o sukladnosti dostupan je na sljedećoj internetskoj adresi: doc.vosshub.com
- HU: VESTEL Elektronik Sanayi ve Ticaret A.Ş., igazolja, hogy a MONITOR típusú rádióberendezés megfelel a 2014/53/EU irányelvnek. Az EU-megfelelőségi nyilatkozat teljes szövege elérhető a következő internetes címen: doc.vosshub.com
- IT: Il fabbricante, VESTEL Elektronik Sanayi ve Ticaret A.Ş., dichiara che il tipo di apparecchiatura radio MONITOR è conforme alla direttiva 2014/53/UE. Il testo completo della dichiarazione di conformità UE è disponibile al seguente indirizzo Internet: doc.vosshub.com
- LT: Aš, VESTEL Elektronik Sanayi ve Ticaret A.Ş., paMONITORirtinu, kad radio įrenginių tipas MONITOR atitinka Direktyvą 2014/53/ES. Visas ES atitikties deklaracijos tekstas prieinamas šiuo interneto adresu: doc.vosshub.com
- LV: Ar šo VESTEL Elektronik Sanayi ve Ticaret A.Ş., deklarē, ka radioiekārtā MONITOR atbilst Direktīvai 2014/53/ES. Pilns ES atbilstības deklarācijas teksts ir pieejams šādā interneta vietnē: doc.vosshub.com
- MT: B'dan, VESTEL Elektronik Sanayi ve Ticaret A.Ş., niddikjara li dan it-tip ta' taghmir tar-radju MONITOR huwa konformi mad-Direttiva 2014/53/UE. It-test kollu tad-dikjarazzjoni ta' konformita tal-UE huwa disponibbli f'dan l-indirizz tal-Internet li gejj: doc.vosshub.com
- NL: Hierbij verklaar ik, VESTEL Elektronik Sanayi ve Ticaret A.Ş., dat het type radioapparatuur MONITOR conform is met Richtlijn 2014/53/UE. De volledige tekst van de EU-conformiteitsverklaring kan worden geraadpleegd op het volgende internetadres: doc.vosshub.com
- PL: VESTEL Elektronik Sanayi ve Ticaret A.Ş., niniejszym oświadczam, że typ urządzenia radiowego MONITOR jest zgodny z dyrektywą 2014/53/UE. Pełny tekst deklaracji zgodności UE jest dostępny pod następującym adresem internetowym: doc.vosshub.com
- PT: O(a) abaixo assinado(a) VESTEL Elektronik Sanayi ve Ticaret A.Ş., declara que o presente tipo de equipamento de rádio MONITOR está em conformidade com a Diretiva 2014/53/UE. O texto integral da declaração de conformidade está disponível no seguinte endereço de Internet: doc.vosshub.com
- RO: Prin prezenta, VESTEL Elektronik Sanayi ve Ticaret A.Ş., declară că tipul de echipamente radio MONITOR este în conformitate cu Directiva 2014/53/UE. Textul integral al declarației UE de conformitate este disponibil la următoarea adresă internet: doc.vosshub.com
- SK: VESTEL Elektronik Sanayi ve Ticaret A.Ş., týmto vyhlasuje, že rádiové zariadenie typu MONITOR je v súlade so smernicou 2014/53/UE. Úplné EÚ vyhlásenie o zhode je k dispozícii na tejto internetovej adrese: doc.vosshub.com
- SL: VESTEL Elektronik Sanayi ve Ticaret A.Ş., potrjuje, da je tip radijske opreme MONITOR skladen z Direktivo 2014/53/UE. Celotno besedilo izjave EU o skladnosti je na voljo na naslednjem spletnem naslovu: doc.vosshub.com
- SV: Härmed försäkrar VESTEL Elektronik Sanayi ve Ticaret A.Ş., att denna typ av radioutrustning MONITOR överensstämmer med direktiv 2014/53/UE. Den fullständiga texten till EU-försäkran om överensstämmelse finns på följande webbadress: doc.vosshub.com
- RU: Настоящим компания VESTEL Elektronik Sanayi ve Ticaret A.S. заявляет, что радиоборудование типа ЖК ДИСПЛЕЙ соответствует Директиве 2014/53/ЕU. Полный текст декларации соответствия ЕС доступен по следующему адресу в Интернете address: doc.vosshub.com







**Vestel Trade Co.**

Organize Sanayi Bölgesi, 45030 Manisa/Türkiye

**Phone:** 90 - 236 233 25 82

**Fax:** 90 - 236 233 25 84

vesteltrade@vestel.com.tr

www.vestel.com.tr

**Vestel France S.A.**

17 Rue de la Couture-Silic BP 10190-94563 RUNGIS  
Cedex/France

**Phone:** 33 - 1 46 75 00 29

**Fax:** 33 - 1 41 80 99 31

vestel@vestel-france.fr

**Vestel Holland B.V. Germany Branch Office**

Parking 6 D-85748 Garching

**Phone:** 49 - 89 55295 - 0

**Fax :** 49 - 89 55295 - 2000

info@vestel-germany.de

www.vestel-germany.de

**Vestel Iberia**

Avda,Partenon,16-18 Planta 1 Oficina 6, 28042 Madrid/

**SpainPhone:** 34-91 320 63 98

**Fax:** 34-91 320 52 58

vestel@vestel.es www.vestel.es

**Gruppo Industriale Vesit S.P.A**

Società Unipersonale Via Polidoro da Caravaggio,

6 20156 Milano (MI)

**Phone:**+39 02 842 48577

**Fax:** +39 02 842 48617

info@givesit.it www.givesit.it

**Vestel UK Ltd**

Vestel House, Waterside Drive

Langley, Berkshire SL3 6EZ

**Phone:** 44 3330 146 400

info@vestel-uk.com

www.vestel.co.uk

**Vestel Benelux B.V.**

P.O. Box 29179 3001 GD - Rotterdam / Netherlands

**Phone:** 31 - 10 235 1000

**Fax:** 31 - 10 235 1003

info@vestelbenelux.nl

www.vestelbenelux.nl

**Vestel Scandinavia**

Postikatu 4, FI-04400 Järvenpää / Finland

**Phone:** +358 46 712 2262

**Fax:** +358 (0) 9 251 7 8222

**Vestel CIS Ltd.**

1-st Graivoronovskiy Proezd, No.20 Building 16, 109518,

Moscow /Russia

**Phone:**7 - 095 956 8230

**Fax:** 7 - 095 956 8233

info@vestel.ru

**Vestel Electronica**

Str Zidarului nr 9-11, Sector 5 Bucuresti, ZIP 051765

Bucharest/Romania

**Phone:** 40- 31 425 42 93

**Fax:** 40-31 425 42 95

www.vestel.ro Office@vestel.ro www.vestel.co



50716053

